

Adaptive Control in Optical Burst-switching Networks with QoS Support

Nasser-Eddine Rikli and Khalid Al-Omran

*Department of Computer Engineering, College of Computer & Information Sciences,
King Saud University, Riyadh, Saudi Arabia
Email: nrikli@ccis.ksu.edu.sa*

(Received 1 May 2006; accepted for publication 16 April 2007)

Abstract. An adaptive control scheme is proposed for the transmission of packets burst in an all-optical Burst Switching network. Two levels of control have been considered: one at the triggering level for a wavelength request, and the other at the burst length level. It is believed that the proposed scheme improves both the provided QoS and the class separation in the wavelength-routed optical network. A comparative study with two other schemes will be undertaken, followed by a study of the effects of the triggering policy. Performance results under various network conditions and dynamic bursty traffic will be presented.

1. Introduction

As the bandwidth scarceness for ever-increasing interactive and real-time traffic deepens, alternative high-speed transmission systems have become a valuable commodity. The premium choice is to use the optical spectrum to carry data through glass or plastic fibers. The huge offered bandwidth is in the *terra bits per second* and is made available through wavelength-division multiplexing (WDM), which is in essence similar to frequency-division multiplexing but in optical domain. WDM networks have evolved considerably for both local and metropolitan applications [1].

The major challenge in WDM networks, however, is due to the inherent nature of the technology itself. Most, if not all, switching, routing, and multiplexing functions are carried out electronically. So, two alternatives are currently proposed and being used [2]:

- Option 1:* Convert the optical signals into electronic form, perform the needed operations electronically, and then convert the signals back to light.
- Option 2:* Carry the optical signals through the network without any of the above-mentioned operations. Wavelength conversion is used instead to route data efficiently to its destination [3].

The first option is chosen in cases where *packet-switching*-like networks are needed. Of major concern are the cost and delay incurred due to the light-to-electronic and electronic-to-light conversions. The second option provides *circuit-switching*-like service. In this case, the wasted bandwidth and high cost per provided bit-rate are of major concern.

It is worthwhile mentioning that there is still a third option that has been proposed recently [4]. It is a hybrid technique that sends the data payload in optical format along with an electronic packet label. Although the technique seems to be promising, it is still in the development and testing phases and may not be deployable until all pending technical difficulties are resolved.

In the meantime, Optical Burst-Switching (OBS), which has been proposed by Yoo and Qiao [5-8], is still the best available alternative to the two above-mentioned techniques. It provides the benefits of the previous techniques while avoiding their drawbacks. This is achieved through the edge-routers, which represent gateways between the electronic and optical worlds. All packets destined to the same edge router and with the same class-of-service are first grouped into a single burst, which then will request a dedicated route, and finally will cut through the optical network to the destination edge-router at once.

Research interest in designing efficient OBS protocols for carrying Internet traffic with QoS provision has grown considerably [9-11]. The new challenge being the optimization of network resources to carry real-time traffic with low and predictable delays while minimizing packet loss rate.

Many wavelength-routed (WR) schemes have been proposed to provide such goal through CoS (Class of Service) separation for various types of traffic. In [12, 13], two schemes were considered, namely the Limited Burst Size (LBS) and Unlimited Burst Size (UBS) scheme. In [14], a new scheme, Adaptive Burst Size (ABS), was proposed to alleviate certain limitations in the existing schemes, and improve the network performance in terms of high wavelength utilization, reduced packet loss rate, and acceptable average total packet delay. Further improvement was proposed in [15], where a hybrid triggering mechanism for sending a wavelength request to the central controller was presented.

The WR-OBS scheme, to be used in this study, extends on the work in [14, 15]. It combines on one hand the advantages of electronic buffering and processing at the network edge nodes, with the high capacity wavelength routing at the core nodes on the other. Packets are aggregated at the network edge into bursts, according to their destination and class of service (CoS). Although a centralized network management control scheme was assumed here, a distributed network management control scheme may be used as well, but would rely on perfect synchronization and fast distribution of information on the state of the network.

This study will consist of two main parts. In the first part, a feasibility study will be conducted by comparing the performance of the proposed ABS scheme to two other schemes widely used in the literature. Namely, these are the Limited Burst Size scheme (LBS) and Unlimited Burst Size scheme (UBS) [9, 10]. The implementation of the LBS scheme will effectively induce a gated system, since the burst to be transmitted will include only the packets received earlier than the light-path request; all packets arriving afterwards will be assembled and transmitted in the next burst.

The implementation of the UBS scheme, on the other hand, will induce an exhaustive system. In this case, once the edge node receives a light-path assignment ACK, it will start transmitting the aggregated burst, and any packet arriving before or during burst transmission, until the buffer is totally emptied.

In the second part of this paper, and after the superiority of the ABS proposed scheme will be confirmed, further scrutinizing of its operation will be undertaken. Three variations of the scheme will be considered. In the first scheme, the light-path request will be initiated by the burst size only. In the second scheme, it will be initiated by the maximum delay incurred by the front-end packet. In the third scheme, the initiation of the light-path request will be based on a function combining both the burst size and the maximum delay.

The drive for the third suggested light-path triggering scheme was the need for ensuring a QoS for real-time traffic, especially at light traffic conditions. Fortunately, under such conditions, the network may tolerate an earlier than usual light-path request initiation.

The rest of the paper will consist of the system description in Section 2. Followed in Section 3 by the comparison of the performance of ABS scheme with the LBS and UBS schemes. In Section 4, three variations of the suggested ABS scheme will be presented and studied. Lastly, in Section 5, the conclusion and findings will be included.

2. System Description

A WR-OBS network may be conceptualized using the model shown in Fig. 1. The network consists of two networks: one carrying low-rate data in an electronic format, and the second carrying high-rate data in light bursts. The traffic in the first network originates from users LANs, high performance terminals, or other low-rate networks. While the second is a backbone network characterized by high-speed optical links. The two networks are then linked through edge-routers where the OBS algorithms are to reside, and it is assumed that a central controller arbitrates and honors the requests sent by the edge-routers.

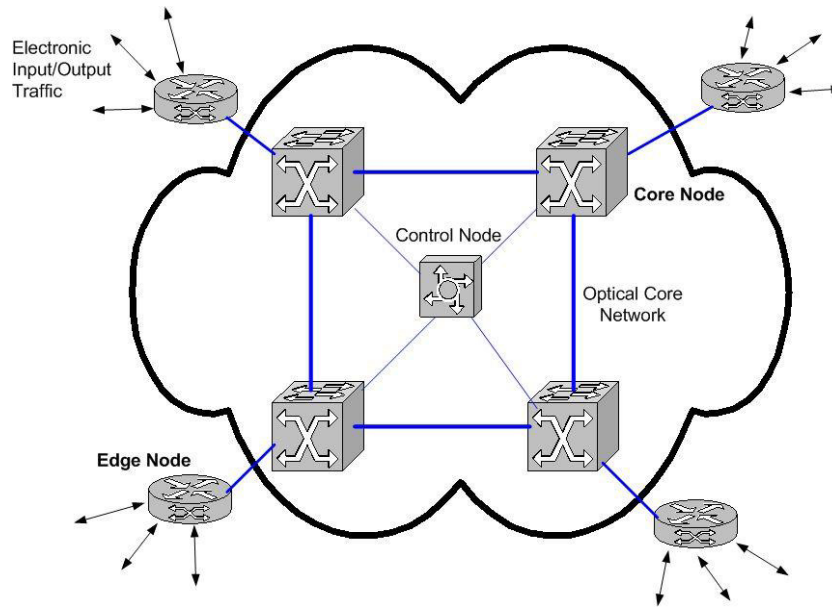

Fig. 1. The WR-OBS network.

Furthermore, the network is assumed to provide various class-of-services (CoS) through the control of the light-path triggering and initiation processes at the edge nodes. No extra processing will be needed thereafter; the burst will just cut through to the destination edge node. In this study, three light-path triggering schemes will be proposed. One is based on the actual buffer size at the sending edge-node, while the other is based on the delay incurred by the head-packet of the burst being assembled.

The third scheme will combine the virtues of the previous two schemes and avoid their drawbacks.

In the former case, the current aggregated burst size B_{Tri} is used as a trigger for initiating a light-path request to the central controller. Thus, as soon as the aggregated burst size in a specified buffer at an edge node exceeds a certain level, it triggers a light-path request that will be sent to the central controller.

It is expected that such policy will be efficient only under heavy traffic loads. As soon as the traffic load lightens, the incurred delays may become prohibitively high, and if any time-out is used, the packet losses may become high as well. Of course trying to remedy this by using a smaller burst size trigger may be contrary to the essence of OBS itself, so it would make more sense to transmit the packets as soon as they arrive.

In the latter case, the delay t_{Tri} incurred by the first packet in the aggregated burst is used as a trigger for sending a light-path request to the central controller. That is, as soon as the delay exceeds a predetermined level, it triggers a light-path request. It is expected that the network performance under such scheme will be best under light load conditions. However, as the traffic load picks up, the network performance may deteriorate drastically since there will be ample time for the buffers to overfill and start dropping all the excess traffic. In the best circumstances, this may lead to a huge burst size that may hog the reserved path for a suboptimal period of time and cause a skewed distribution of resources.

Given the limitations mentioned in the above-described triggering policies, a combination of the two triggering policies may seem an ideal solution. Thus, in the proposed ABS scheme, either the buffer size or the maximum incurred delay may trigger the initiation of a light-path request; whichever occurs first. It is expected that the triggering process will be mainly initiated due to the buffer size reaching the limit under heavy load conditions. While under light loads, it is more likely that delay incurred by the head packet will be the trigger for the light-path request initiation.

Upon reception of the light-path request, it is assumed that the control node will process it in a FIFO manner. It will set the burst transmission time based on various parameters that include the average arrival rate to the edge node queue, the delay time spent by the light-path request in the central node queue, and the propagation time from and to the edge node. Consequently, the assigned service time (wavelength holding time) will adapt easily to the varying network conditions. In particular, it will minimize the overhead associated with the light-path request, and ensure that the assigned wavelength reservation time will be enough for the edge node to transmit all packets received prior to getting the light-path assignment ACK.

3. Performance Analysis

A network with four core nodes connected in a mesh-torus topology, and with two edge nodes per core node is to be considered. Two wavelengths per link are assumed, each with a capacity of 10 Gbps. A propagation delay, t_{prop} , of 3 msec and a separate control channel were assumed. Traffic arriving to a core node is assumed divided equally into two classes of service with class 1 having higher priority over class 2. The times of arrival are assumed to be Poisson distributed with fixed packet length of 1500 bytes. The light-path trigger controls values are: $B_{TR1} = 0.3$; $B_{TR2} = 0.4$, and $t_{TR1} = 0.05$ sec; $t_{TR2} = 0.14$ sec for class 1 and class 2, respectively. The buffer size allocated for each queue (destination) at the edge router is assumed to be 32 MB.

The performance of the proposed ABS scheme will be compared to both the LBS and UBS schemes. The performance measures to be used are the utilization, packet delay, and packet loss.

3.1. Utilization

From Fig. 1, we see that regardless of the used burst size scheme, there are no significant differences of utilization if the network load is below 0.5 (Load per Wavelength capacity equal 0.5). But, comparing the different burst size schemes in the presence of higher network load, the ABS scheme is outperforming the UBS and LBS schemes; UBS scheme is coming close and next to ABS scheme. For example, at full load (Load per Wavelength capacity equal 1) the utilization for different burst size schemes are for ABS ~ 0.73 , for UBS ~ 0.71 and for LBS ~ 0.6 .

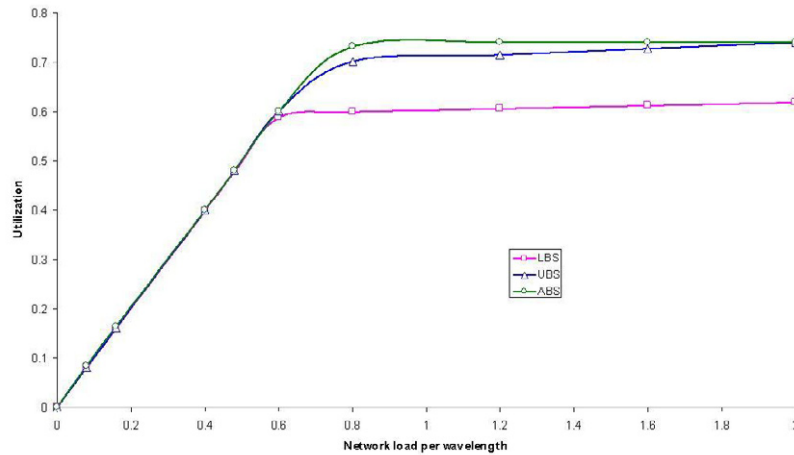

Fig. 1. Wavelength utilization vs. network load.

At very high network loads (>2), the UBS scheme utilization is higher than ABS scheme, as the UBS scheme can transmit longer burst sizes, but such network loads considered to be not practical to operate in any network.

3.2. Packet delay

The results shown in Fig. 2 show the average total packet delay for the three schemes. The LBS has the worst performance in magnitude and CoS separation. It achieved the worst (highest) delay, and did keep the CoS separation only in a narrow load interval from 0 up to 0.4. Then it reversed the CoS separation up to 0.6. Afterwards, the two classes were treated the same.

In the case of both ABS and UBS, the average total delay was lower and CoS separation was achieved distinctively for a load little less than 1.2. In this range, the Class-2 traffic achieved better performance with ABS scheme, but Class-1 only up to 0.7, and then UBS was better. In the last load range of above 1.2, both schemes lost the capability of CoS separation, and UBS had a better performance than ABS.

As an example, only the ABS and UBS schemes can support the requirements of a high priority class with a maximum end-to-end delay of at most 100 ms up to a traffic load of 0.6, while LBS can achieve this only up to a load of 0.2.

It is worthwhile mentioning that the average delay in all three cases levels off as the traffic load is increased. This is due to the assumption of finite buffer sizes.

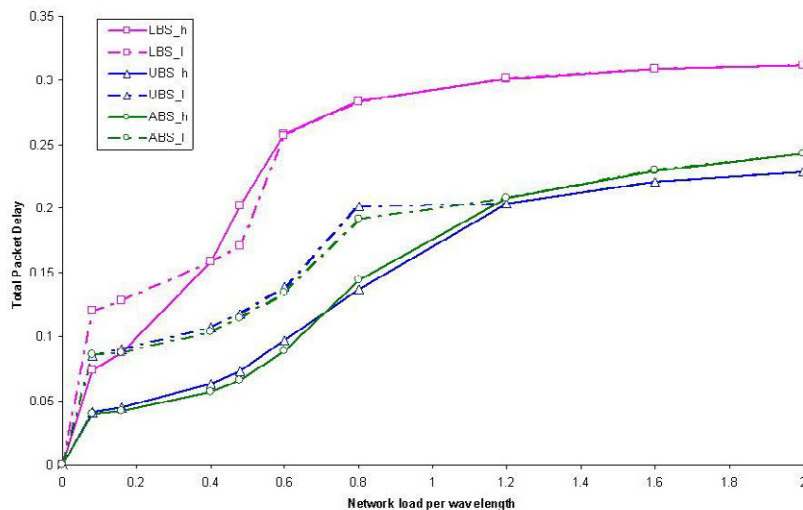

Fig. 2. Average total packet delay (T) vs. load.

3.3. Average packet loss

Figure 4 shows the price for low delay performance of ABS and UBS schemes. Clearly, LBS has the poorest performance magnitude-wise and no CoS separation for all load ranges. However, both ABS and UBS achieved lower average packet loss than LBS. They also achieved a clear CoS separation in the active load range from 0.6 to 1.2. Also, ABS had a significant advantage over UBS in the same active region, due to its blended constituency.

Contrary to the previous performance measures (i.e., utilization and packet delay), the packet loss does not level off, but keeps increasing as the traffic load is increased. This results from the limited capacity of the buffers which cannot accommodate all incoming traffic.

In conclusion, the ABS scheme proved to be performing the best compared to the other schemes. Over a wide range of network loads, the ABS scheme achieved CoS separation while achieving a good utilization, lower average packet loss and average packet delay.

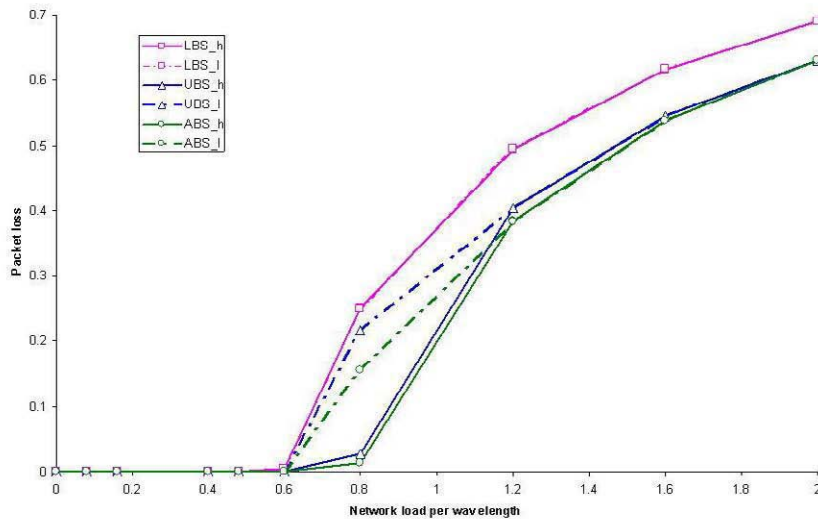

Fig. 4. Packet loss rate (PLR) vs. utilization.

4. Effects of the triggering Policy

In this section, the effects of the three mentioned triggering policies will be studied. This will allow fine-tuning of the ABS scheme. The considered network a mesh-torus with four core nodes, and two edge nodes per core node is considered. Two wavelengths per link were assumed, each with a capacity of 10 Gbps. A propagation delay, t_{prop} , of 1 msec was assumed, which corresponds to a distance of 200 km. It is assumed that control data is sent over a separate control channel. Finally, a finite buffer size of 32 Mbytes¹ was assumed at each edge router, i.e. if the buffer size is exceeded, all packets arriving thereafter will be blocked, and since no retransmission is assumed, they will be consequently lost.

Two classes of service were assumed, with class-1 being of higher priority than class-2. Class-2 is assumed to contribute with three times more traffic than class-1. All packets are assumed to arrive to the edge nodes according to a Poisson process with fixed packet lengths of 1500 bytes.

The light-path trigger values when using the burst size as criterion, were $B_{TR1} = 25\%$ for class-1 and $B_{TR2} = 50\%$ for class-2 of the allocated buffer size. The trigger values when using the time delay as criterion, were $t_{TR1} = 30$ ms for class-1 and $t_{TR2} = 60$ ms for class-2. The same values were used in the case of the combined scheme.

The performance measures to be used in this comparison are the utilization, the packet loss rate, and the average packet delay.

4.1. Average total delay

In Fig. 5. is plotted the average total delay incurred by a packet as a function of the average offered load per wavelength. At almost all loads, the delay performance is the best with the combined-triggering scheme, and then comes the delay-triggering scheme.

There is, however, an exception to this rule for class-2 traffic. When using the buffer-triggering scheme, the average delay becomes less than that obtained using the delay-triggering scheme for loads greater than 0.9, and it becomes less than that obtained using the combined-triggering scheme later on for loads greater than 1.35.

The CoS differentiation with respect to delay does exist only in the delay-triggered and combined-triggered schemes, although the latter scheme has a slight advantage at low loads. Although the buffer-triggering scheme has a much significant differentiation at low loads, it should not be considered since: (i) the delay magnitudes

¹ This is equivalent to 25.6 ms worth of data when sent at a channel transmission rate of 10 Gbps.

are much higher at low loads than the two other schemes, and (ii) the differentiation gets smaller as the load increases, and worst (iii) the differentiation is reversed at loads greater than 1.

Thus, the combined-triggering scheme outperforms the two other schemes in average delay levels and delay-based class separation for all practical traffic intensities.

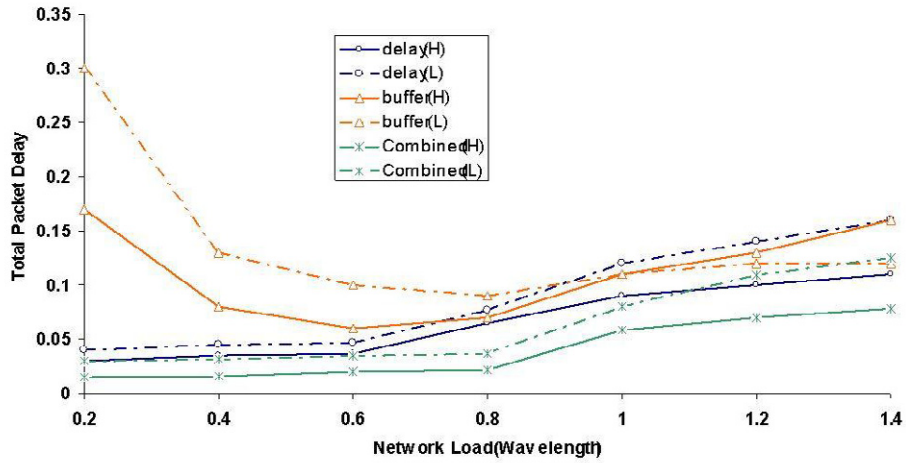

Fig. 5. Total packet delay versus network load.

4.2. Packet loss rate

The results for the second performance measure are shown in Fig. 3. The packet loss rate, which may be used as a second measure for CoS separation, is plotted as a function of network load. The CoS separation is evidently marked in all three schemes. There is, however, a slight advantage of the delay-triggering scheme over the combined-triggering scheme for loads greater than 1.8.

Thus, contrary to the previous measure, it seems that the packet loss measure is basically indifferent to the triggering mechanism being used, and in all cases provides a very clear and distinctive CoS separation.

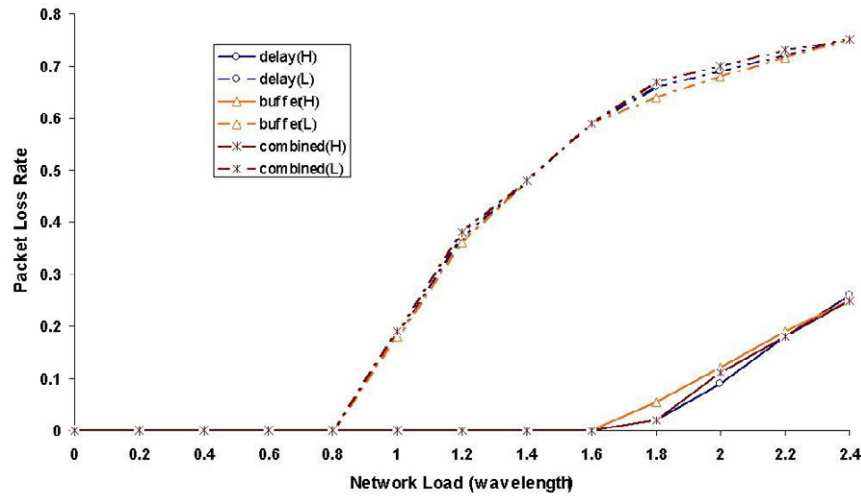

Fig. 3. Packet loss rate versus network load.

4.3. Utilization

Lastly, Fig. 7 shows the results for the channel utilization. This performance measure may be considered as the trade off, or the price paid, for achieving a certain CoS separation. Generally, the graphs may be divided into three regions. For low loads (< 0.2) and high loads (> 2), the three schemes performances are very close. For loads in between these limits, the buffer-triggering scheme achieved the highest utilization, while the combined-triggering scheme was the worst, or at best the same as the delay-triggering scheme. Under all traffic loads, however, the difference between the achieved utilizations in the three triggering schemes did not exceed 13%.

In conclusion of this section, it seems that if the average delay were the premium performance measure, then using the suggested combined-triggering scheme would be useful, since it will provide the best performance while providing CoS separation. The two remaining measures will still achieve comparable results with a minor decrease in the performance of the suggested scheme.

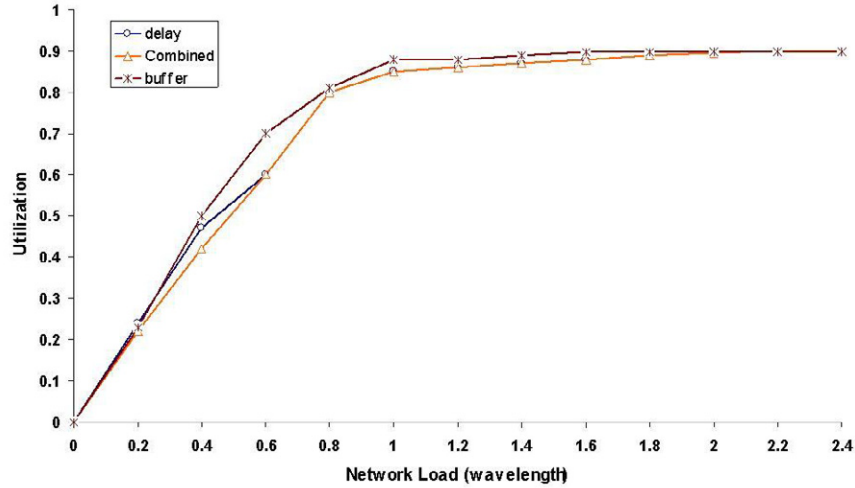

Fig. 7. Channel utilization versus network load.

5. Conclusions

In this paper, a WDM network was considered. The focus was on the provision of quality-of-service through the separation of traffic into various classes. Then, the packet transmission is based first on grouping packets of the same class into a single burst, and then on the control of the size of this burst. An ABS adaptive technique was proposed for this aim. A comparison showed that the ABS scheme outperforms the LBS and UBS schemes under all practical network conditions. Effectively, over a wide range of network loads, the ABS scheme achieved not only class of service separation, but introduced good network utilization and lower packet loss rates and delays as well.

Then in the second part of this study, a new triggering scheme for initiating light-path requests to the central controller for the reservation of a wavelength was proposed. It was then compared to two other triggering schemes. From the obtained results, the improvement was significant in the case where the CoS separation is based on the average total packet delay. However, if the CoS separation is based on the packet loss rate, the improvement is not that significant. In all cases, however, it was concluded that the decrease in the network utilization was still acceptable and worth the gain achieved.

References

- [1] Mukherjee, Biswanath. "WDM Optical Communication Networks: Progress and Challenges." *IEEE Journal on Selected Areas in Communications*, 18, No. 10, (October 2000).
- [2] VanCaenegem, R. "From IP Over WDM to All-optical Packet Switching: Economical View." *IEEE Journal of Lightwave Technology*, 24, No. 4, (April 2006), 1638 - 1645.
- [3] Ho, Quang-Dzung. and Lee, Man-Seop. "Time-efficient Optimal Wavelength Assignment in Optical WDM Networks with Conversion Capability." *IEEE Communications Letters*, 10, No. 3, (March 2006), 198 - 200.
- [4] Nadarajah, N.; Wong, Elaine and Nirmalathas, A. "Packet Labeling Technique Using Electronic Code-division Multiple-access for WDM Packet-based Access Networks." *IEEE Photonics Technology Letters*, 18, No. 4, (Feb. 2006), 607-609.
- [5] Yoo, M. and Qiao, C. "Just-enough-time (JET): A High Speed Protocol for Bursty Traffic in Optical Networks." *IEEE/LEOS Technol. Global Information Infrastructure*, (Aug. 1997), 26-27.
- [6] Yoo, M.; Jeong, M. and Qiao, C. "A High Speed Protocol for Bursty Traffic in Optical Networks." *SPIE Proc. All Optical Commun. Syst.: Architecture, Control Network Issues*, 3230, (Nov. 1997), 79-90.
- [7] Qiao, C. and Yoo, M. "Optical Burst Switching (OBS): A New Paradigm for an Optical Internet." *Journal of High Speed Network*, 8, (1999), 69-84.
- [8] Yoo, M. and Qiao, C. "A New Optical Burst Switching (OBS) Protocol for Supporting Quality of Service." *SPIE Proc., All Optical Commun. Syst.: Architecture, Control Network Issues*, 3531, (Nov. 1998.), 396-405.
- [9] Teng, Jing. and Rouskas, George N. "Wavelength Selection in OBS Networks Using Traffic Engineering and Priority-based Concepts." *IEEE Journal on Selected Areas in Communications*, 23, No. 8, (August 2005).
- [10] Düser, Michael. and Bayvel, Polina. "Analysis of a Dynamically Wavelength-routed Optical Burst Switched Network Architecture." *Journal of Lightwave Technology*, 20, No. 4, (April 2002), 574-585.
- [11] Wei, J. Y. "Advances in the Management and Control of Optical Internet." *IEEE Journal on Selected Areas in Communications*, 20, No. 4, (May 2002), 768-785.
- [12] Düser, M.; de Miguel, I.; Bayvel, P. and Wischik, D. "Timescale Analysis for Wavelength-routed Optical Burst-switched (WR-OBS) Networks." *Proceedings of Optical Fiber Communication Conference & Exposition*, Atlanta, USA, March 2002.
- [13] de Miguel, Düser, M. and Bayvel, P. "Traffic Load Bounds for Optical Burst-switched Networks with Dynamic Wavelength Allocation." *Proceedings of the IFIP 5th Working-conference on Optical Network Design and Modeling*, Vol. 1, Vienna, Austria, Feb. 2001.
- [14] Al-Omran, K. and Rikli, N. E. "Performance Analysis of Wavelength-routed Optical Burst-switched (WR-OBS) Scheme with Quality of Service Provision." *Proceedings of 10th OptoElectronics and Communications Conference*, Seoul, Korea, July 2005.
- [15] Rikli, N. E. and Al-Omran, K. "Effects of the Triggering Policy on the Performance of an Adaptive Burst Size OBS Scheme with Quality of Service." *Proceedings of 7th International Symposium on Computer Networks*, Istanbul, Turkey, June 2006.

التحكم المتكيف في الشبكات الضوئية الومضية الداعمة لجودة الخدمة

نصرالدين ريكلي و خالد العمران

قسم هندسة الحاسب، كلية علوم الحاسب والمعلومات،
جامعة الملك سعود، الرياض، المملكة العربية السعودية
البريد الإلكتروني: nrikli@ccis.ksu.edu.sa

(قدم للنشر في ٢٠٠٦/٥/١م؛ وقبل للنشر في ٢٠٠٧/٤/١٦م)

ملخص البحث: يقدم البحث طريقة متكيفة للتحكم في إرسال الحزم البينانية في ومضات من خلال شبكة ومضية ضوئية. اعتمد البحث على مستويين اثنين للتحكم: الأول على مستوى الزمن الذي إذا تعدي أرسل طلب موجة، والثاني على مستوى طول الومضة الذي إذا بلغته أرسل طلب الموجة. يعتقد أن الطريقة المقترحة تحسن كلا من جودة الخدمة، والتميز الطبقي في الشبكة الضوئية المعتمدة على الموجات في التوجيه. يقدم البحث أيضا دراسة مقارنة للطريقة المقترحة مع طريقتين أخريين، والآثار الأداةية لطريقة التحكم في إرسال طلب الموجة. في الأخير تعرض نتائج الأداء للطريقة المبتكرة في بيئات شبكية مختلفة، ومع مداخل بيانية متقطعة ومتغيرة.