



ORIGINAL ARTICLE

# An adaptive immune algorithm based gravimetric fluid dispensing machine

David F.W. Yap <sup>a,\*</sup>, Edwin Y.S. Sim <sup>b</sup>, S.P. Koh <sup>c</sup>, S.K. Tiong <sup>c</sup>

<sup>a</sup> Faculty of Electronics and Computer Engineering, Universiti Teknikal Malaysia Melaka (UTeM), Hang Tuah Jaya, 76100 Durian Tunggal, Melaka, Malaysia

<sup>b</sup> School of Engineering, Monash University Sunway Campus, Jalan Lagoon Selatan, 46150 Bandar Sunway, Selangor Darul Ehsan, Malaysia

<sup>c</sup> College of Engineering, Universiti Tenaga Nasional (UNITEN), km 7, Kajang-Puchong Road, 43009 Kajang, Selangor Darul Ehsan, Malaysia

Received 11 April 2011; revised 19 September 2011; accepted 5 October 2011

Available online 15 November 2011

## KEYWORDS

Artificial immune system;  
Volumetric-based fluid  
dispensing;  
Pulse width modulation;  
Gravimetric;  
Materials blending

**Abstract** A dispensing system is used in a materials-mixing plant to provide accurate blend ratios in producing the desired end-use product. The AIS-based (Artificial Immune Systems) fine tuning of dispensing parameters is proposed by optimizing the components of dispensing time and stopping time delay to obtain constant and accurate reading from the precision balance scale. Based on the new dispensing sequence, experimental tests had been carried out using different materials with varying viscosities. The results indicate that the combination of both PWM and AIS techniques would minimize overshoot while exhibiting lower steady-state error and faster response time. These are important in order to overcome the limitations of the conventional volumetric dispensing and manual parameter tuning presently applied in the dispensing system used in the coatings industry.

© 2011 King Saud University. Production and hosting by Elsevier B.V. All rights reserved.

\* Corresponding author. Tel.: +60 6 5552094; fax: +60 6 5552112.

E-mail addresses: david.yap@utem.edu.my (D.F.W. Yap), edwin.sim@monash.edu (E.Y.S. Sim), johnnykoh@uniten.edu.my (S.P. Koh), siehkiang@uniten.edu.my (S.K. Tiong).

1319-1578 © 2011 King Saud University. Production and hosting by Elsevier B.V. All rights reserved.

Peer review under responsibility of King Saud University.

doi:10.1016/j.jksuci.2011.10.005



Production and hosting by Elsevier

## 1. Introduction

Manufacturers in the coating industry encounter difficulties in corrugated carton printing as the number of coatings used can be as high as 30000. Thus, it is impossible and highly unlikely for the manufacturers to store 30000 types of coatings in separate containers. Moreover, the acquisition costs for these coatings would be astronomically high. A solution to this problem called blending was proposed and a typical range of 6–20 base ingredients can be blended to produce thousands of other types of coatings. Hence, the storage requirement can be reduced drastically which is dependent on the amount of base ingredients. In order to match the desired coatings, the printers must mix these base ingredients

carefully and very accurately with regards to a formula or mixing scheme agreed by their customers.

The automatic fluid dispensing systems applied in the coatings industry are normally volumetric-based which operate by a measuring device (metering pump or other components) for each ingredient being dispensed. Volumetric system is susceptible to changes in temperature and air flow, which directly affect the end result in terms of accuracy, speed and quality.

In order to resolve this setback, reference has been studied on Microfluidic System, Inkjet Technology and other system (Steger et al., 2002; Pöschel and Engel, 1998) as well as Pulse Width Modulation (PWM) technique (Bowler, 1995; Foulds and Johnstone, 2005) to adapt the concept for a fast and accurate fluid dispensing technique suitable for coating industry. The result is a gravimetric and PWM based controlled fluid dispensing system (Sim et al., 2009) with Artificial Immune System (AIS) dispensing parameter fine tuning capability. The proposed closed-loop dispensing system would provide the set point weight, the actual weight of each ingredient and real dispensing data as input which are helpful for each dispensed batch in terms of quality control, audit trail and quality-related problems diagnosis. Ingredient usage, formulation usage and batch production are accurately logged as the output of the system and stored in the built-in database where tracking and monitoring of ingredients and formulations used are being carried out from time-to-time. In this active control system, information from one or more sensors in the flow, along with a flow model guides the actuation process.

The developed gravimetric fluid dispensing system is able:

- to dispense batch by batch within accuracy of  $\pm 2$  g,
- to complete the dispensing cycle with optimum performance in terms of faster speed,
- to communicate with AIS dispensing parameter fine tuning technique,
- to prevent settling of the pigment in the base ingredient,
- to dispense via a manual control backup system in the event of PC breakdown,
- to obtain optimum dispense parameters through an adaptive fine tuning system.

The flow chart of the proposed fluid dispensing system is shown in Fig. 1. There are three major parts of the system as follows:

- Dispensing software.
- Hardware design of a single valve gravimetric fluid dispensing system.
- AIS-based dispensing parameter fine tuning.

## 2. Dispensing software architecture

The dispensing software architecture consists of three major components shown in Fig. 2.

The development of the dispensing software can be divided into control of dispensing sequence, control of PWM module and PLC and GUI module. The dispensing sequence of a liquid is pre-determined (as shown in Table 1). Initial flow of the liquid happens when the valve is fully opened. This is termed as Big Flow. Next, when approaching the amount of

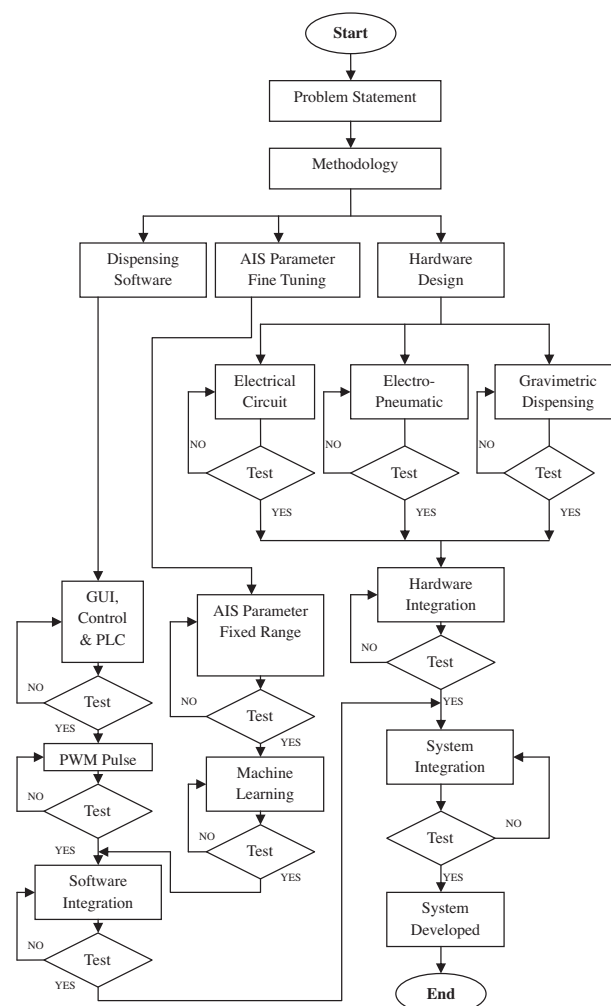

Figure 1 Flow chart of the proposed system development.

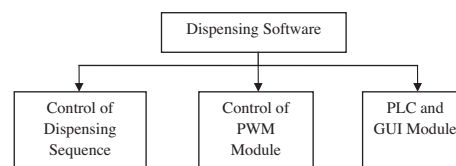
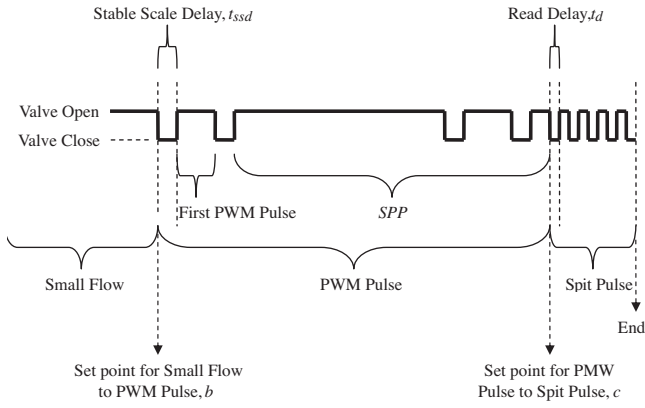

Figure 2 Dispensing software architecture.

Table 1 Dispensing parameters.

Description	Symbol
Set point for Big Flow to Small Flow	<i>a</i>
Set point for Small Flow to PWM Pulse	<i>b</i>
Set point for PWM Pulse to Spit Pulse	<i>c</i>
PWM coefficient	<i>d</i>
Spit coefficient	<i>e</i>

liquid needed to be dispensed, the valve would be slightly closed. This stage is called Small Flow. Subsequently, the



**Figure 3** Timing diagram for PWM pulse technique.

**Table 2** Dispensing modes.

Modes	Description
Big Flow	Dispensing mode starting from start, zero weight
Small Flow	Dispensing mode starting from last weight $a$
PWM Pulse	Dispensing mode starting from last weight $b$
Spit Pulse	Dispensing mode starting from last weight $c$

liquid would be dispensed according to the PWM Pulse. Lastly, on reaching the correct amount of liquid dispensed, the flow would be converted to Spit Pulse (as shown in Fig. 3). Thus, usage of PWM technique is important to enable accurate control of the valve opening from Small Flow up to Spit Pulse.

### 2.1. Control of dispensing sequence

The dispensing parameters and the four major modes used are depicted in Tables 1 and 2, respectively.  $a$ ,  $b$  and  $c$  are set points of each type of flow in the dispensing sequence as shown in Fig. 3. The flow chart of the dispensing sequence is shown in Fig. 4.

Computing the time profile of the dispensing flow is important to optimize the dispensing sequence. The total dispensing time ( $T_D$ ) taken for the dispensing sequence as defined in Eq. (1) is given by the summation of the process time ( $t_p$ ), stable scale delay ( $t_{ssd}$ ), and read delay ( $t_d$ ).

$$T_D = \sum (t_p + t_{ssd} + t_d) \quad (1)$$

The aim of the system is to reduce the dispensing time given by the objective function in the following equation:

$$F = \min \sum T_D \quad (2)$$

### 2.2. Control of PWM module

The parameters used in PWM Pulse technique are depicted in Table 3.

With reference to Table 3, the proposed PWM Pulse would be applied once  $b$  has been achieved. The constraint of Eqs. (3) and (4) must be fulfilled in order to initiate the first PWM Pulse. This constraint enables the smooth transition from

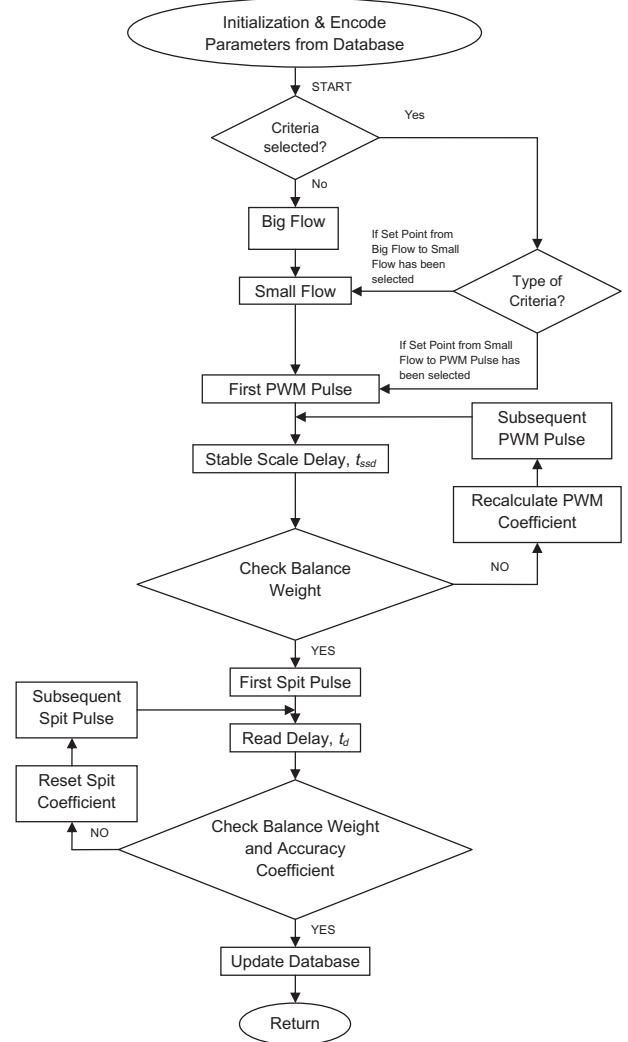

**Figure 4** Flow chart for dispensing sequence.

**Table 3** PWM Pulse technique parameters.

Description	Symbol	Value used
Stable scale delay	$t_{ssd}$	1 s
Read delay	$t_d$	0.5 s
Accuracy coefficient	$ACC$	1

Small Flow to PWM Pulse. In the event that the constraint is not met due to excessive dispensing from Small Flow, the dispensing mode will switch to Spit Pulse (bypass PWM Pulse) to complete the dispensing.

$$\text{Target Weight} - \text{Achieved Weight} \leq \text{Weight for first PWM Pulse} \quad (3)$$

$$\text{Target Weight} - \text{Achieved Weight} > b \quad (4)$$

The way of opening and closing of the dispense valve is an essential part of the PWM technique. First of all, a fast ejection of first pulse is needed to predict the subsequent pulses. Second, a  $t_{ssd}$  is required for the balancer to feedback on the weight of the first pulse. Once the first pulse has been

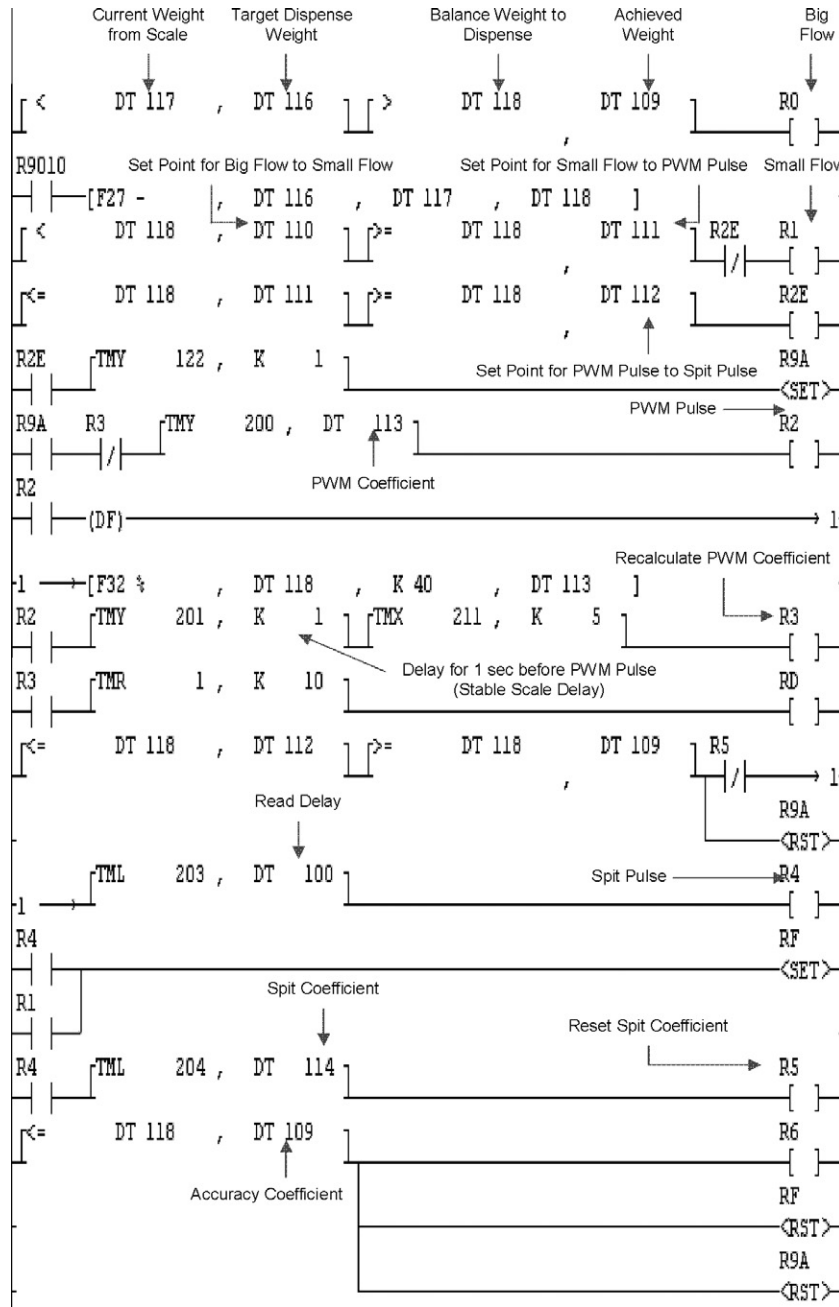

Figure 5 Control mechanism of PLC.

Table 4 Data registers.

Data registers	Description
DT109	Achieved weight
DT110	Set point for Big Flow to Small Flow
DT111	Set point for Small Flow to PWM Pulse
DT112	Set point for PWM Pulse to Spit Pulse
DT113	PWM coefficient
DT114	Spit coefficient
DT116	Target dispense weight
DT117	Current weight from balancer
DT118	Balance weight to dispense

dispensed, (5) would be applied on Subsequent PWM Pulse (*SPP*).

$$SPP = t_{ssd} + \frac{(\text{Target Weight} - \text{Achieved Weight})}{\text{Weight for first PWM Pulse}} * d \quad (5)$$

*SPP* would evolve accordingly based on the input value of Achieved Weight to achieve *c* accurately in the shortest possible time. Width of each *SPP* differs and depends on Achieved Weight as the feedback signal and the multiplicative factor of PWM coefficient (*d*). Once *c* has been achieved, (6) would be used to calculate the Spit Pulse:

$$\text{Spit Pulse} = \frac{(\text{Target Weight} - \text{Achieved Weight})}{e} * ACC \quad (6)$$

Spit Pulse would dispense according to *ACC* to achieve the final Target Weight. *ACC* is the multiplicative factor for accuracy and depends on the system scalability and establishment of acceptable behavior of such during tuning process. This factor is usually set as 1 to achieve real-time accuracy. In the event that flow rate is higher than usual (thus Spit Pulse to dispense more than anticipated), *ACC* should be reduced to less than 1 to achieve the desired output.

Example of one of the timing diagram depicting the PWM Pulse technique is illustrated in Fig. 3. The PWM Pulse technique applied would optimize the accuracy factor without sacrificing speed.

2.3. Programmable logic controller and graphical user interface module

Programmable Logic Controller (PLC) is used to control the operation of the system via electro-pneumatic components. The ladder diagram is drawn using FPWIN GR (Nais PLC programming language) where the control mechanism is illustrated in Fig. 5. The data registers in Table 4 have been used to store the data in real time.

A PC-based program is used to provide a Graphical User Interface (GUI) representation to control the system. It is also used to link and save the dispensed data into a database. Various data that needs to be stored frequently such as achieved weight, target weight, weight for first PWM Pulse, dispensing parameters (as in Table 1) and fixed parameters (as in Table 3) would be saved into the dispensing software database.

3. Gravimetric dispensing hardware setup

The gravimetric dispensing system setup is illustrated in Fig. 6. The system consists of a precision balancer, 20 kg capacity storage barrel, dispensing valve, diaphragm pump, base ingredient storage barrel and system controller with manual backup. Fig. 7 shows the developed dispensing system. When the system is in dormant condition, all pneumatic components except “Close Valve” of the Dispensing Valve remained closed i.e. no

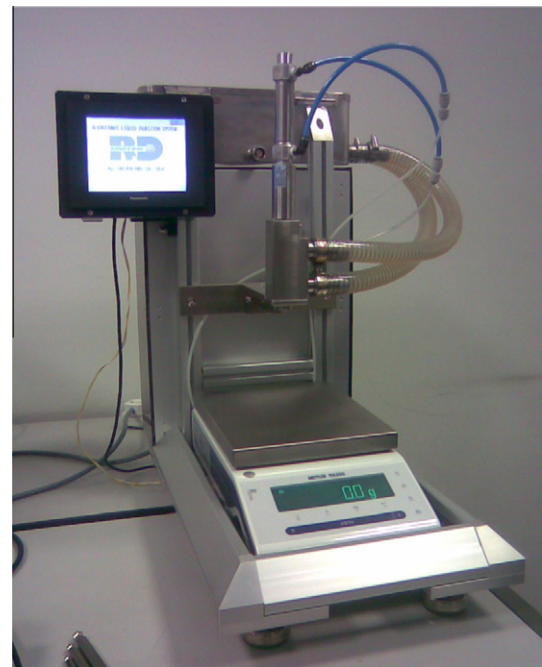

Figure 7 Developed fluid dispensing system.

output. When a dispensing process is selected, PLC would first energize the diaphragm pump to allow the ingredients to flow and recirculate at the dispense valve. With the recirculation of the ingredient at the dispense valve, the valve would be able to eject the ingredients once opened. Simultaneously, the PLC would energize the “Open Valve” of the Dispensing Valve accordingly. The valve would then open fully (Big Flow) and dispense the ingredient accordingly (with sequence of Small Flow, etc.). At the end of the dispensing sequence, PWM technique is applied to alternate the “Close Valve” and “Open Valve” at different timing to dispense accurately in order to achieve the target weight in shortest duration. In the event of system breakdown, manual control backup that consists of

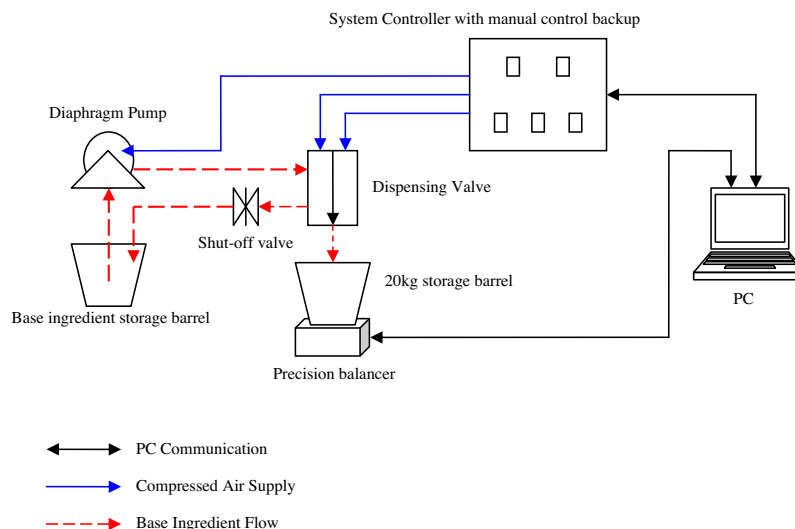
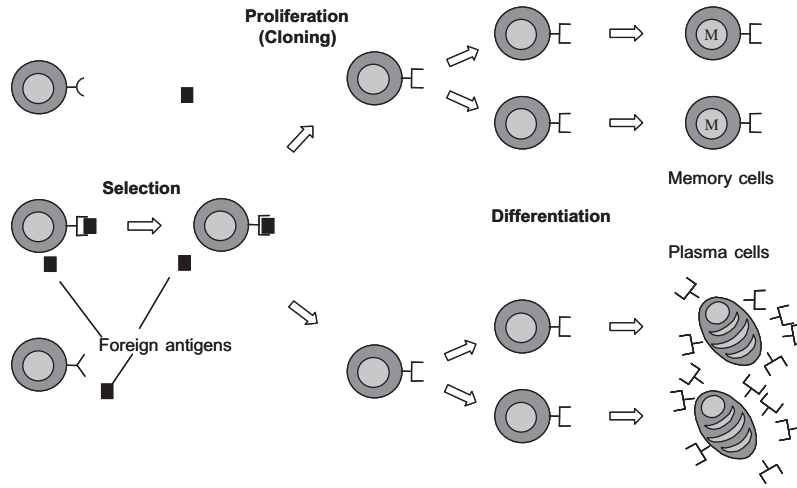

Figure 6 Gravimetric dispensing system setup.





**Figure 8** The clonal selection theory.

```

begin AIS
c:=0 { counter }
Initialize population
Do:
  Compute affinity
  Generate clones
  Mutate clones
  Replace lowest affinity Ab with a new randomly generated Ab
  c:=c+1
end
end AIS

```

**Figure 9** Pseudo-code of the clonal selection algorithm.

Fast/Slow Dispense Selector, Recirculate/Auto/Manual Selector and Emergency would be used to ensure unrestrictive production. However, tracking and monitoring of the usage of the ingredients, formulations and batches are not applicable for manual control backup.

#### 4. AIS-based fine tuning of dispensing parameters

##### 4.1. Artificial immune system – clonal selection for optimization

Artificial Immune Systems (AIS) are inspired by theoretical immunology and observed immune functions, principles and models, which are applied to engineering problem solving (De Castro and Timmis, 2002a). The clonal selection algorithm is a branch of AIS with principles extracted from clonal expansion and affinity maturation (De Castro and Zuben, 2002). The clonal selection theory explains that when an antigen (Ag) is detected, antibodies (Ab) that best recognize this Ag will proliferate by cloning. This immune response is specific to each Ag.

The immune cells will reproduce in tandem with a replicating Ag until it is successful in recognizing and fighting against this Ag. Some of the new cloned cells will be differentiated into plasma cells and memory cells. The plasma cells produce Ab and will undergo mutation that will promote their genetic variation. The memory cells are responsible for the immunologic response for future Ag invasion. Subsequently, the selection mechanism will keep the cells with the best affinity to the Ag in the next population. In this high-affinity cells, hypermutation is inactivated. However, mutation may further occur in cells with low affinity receptors and finally die through apop-

**Table 5** AIS parameters.

Parameters	Specification
Population size	20
Clone size factor	2
Maturation rate	0.40
Criteria termination	30 generations

**Table 6** Fine tuning range dispensing parameters.

Dispensing parameters	Range	
	Min	Max
Set point for Big Flow to Small Flow, $a$	300 g	500 g
Set point for Small Flow to PWM Pulse, $b$	50 g	300 g
Set point for PWM Pulse to Spit Pulse, $c$	10 g	50 g
PWM coefficient, $d$	0	5
Spit coefficient, $e$	1000	2000

tosis (programmed cell death) (Kepler and Perelson, 1993). The whole clonal selection process is shown in Fig. 8. The process of a standard clonal selection algorithm can be characterized in pseudo-code format in Fig. 9. The summary of the clonal selection optimization is described as (De Castro and Timmis, 2002b):

1. Generate a random initial population of Ab.
2. Compute the fitness of each Ab.
3. Generate clones by cloning all cells in the Ab population.
4. Mutate the clone population to produce a mature clone population.
5. Evaluate affinity values of the clones' population.
6. Select the best Ab to compose the new Ab population.
7. Steps 3–6 are repeated until a pre-defined stopping condition is reached.

##### 4.2. AIS parameter range determination

The experiment was conducted using the AIS parameters as shown in Table 5. Note that the required size of population

is relatively small as each given Ab is set within a fixed range as depicted in Table 6, which caters for all dispensing weight. This would reduce the searching space, hence reducing the number of Abs and generations required for convergence. The flow chart of the AIS dispensing parameter fine tuning program is shown in Fig. 10.

4.3. Fitness function

The overall fitness function ( $F$ ) consists of the fitness of accuracy ( $F_e$ ) and speed ( $F_s$ ) obtained from online measurements of the precision balancer and the total dispensing time. The fitness function is defined by (7)–(10) where Accuracy is the real-time value of measured weight from the precision balancer and Speed is the total dispensing time upon completion of one dispensing work.

$$F = 1/\{\exp[uF_{es}]^v\} \tag{7}$$

where

$$F_{es} = F_e * F_s \tag{8}$$

$$F_e = 1/\{1 - \exp[w(\text{Accuracy})^x]\} \tag{9}$$

$$F_s = 1/\{1 - \exp[y(\text{Speed})^z]\} \tag{10}$$

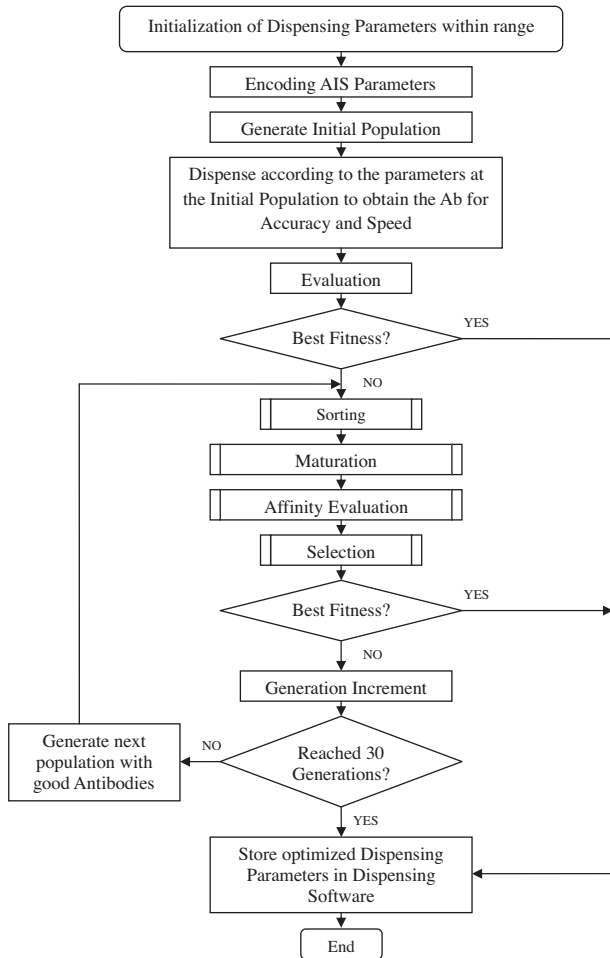

Figure 10 Flow chart of the AIS dispensing parameter fine tuning program.

Table 7 Viscosity of the tested materials.

Medium	Dynamic viscosity at room temperature (pascal-second)
A	$8.94 \times 10^{-4}$
B	$1.06 \times 10^{-3}$
C	0.81

The exponential function is applied in the AIS optimization process to allow the overall fitness function ( $F$ ) to gradually reach the peak. Coefficient  $u$  determines the sensitivity of the fitness function ( $F$ ). In this application, coefficients  $w$  and  $x$  were set to  $-0.015$  and  $0.6$  while coefficients  $y$  and  $z$  were set to  $-0.02$  and  $0.6$ . These settings are to prioritize the accuracy over speed in the overall fitness function ( $F$ ). To further fine-tune the overall exponential fitness, coefficients  $u$  and  $v$  are set to  $-0.3$  and  $0.45$ .

5. Experimental results

Three different types of fluids with varying viscosity as shown in Table 7 were applied into the dispensing sequence for characterization and to establish the reliability of the system.

First of all, the dispensing parameters described in Table 1 are fine-tuned using AIS to obtain the optimum dispensing parameters for all the mediums. The system is then dispensed according to the array of antibodies which represent the solutions to obtain the primary fitness function. Thereafter, the primary fitness function will undergo selection and affinity maturation to obtain the best fitness in terms of accuracy and speed.

5.1. Performance result after AIS dispensing parameter fine tuning

Upon confirmation of the optimum dispensing parameters via AIS, the reproducibility and consistency of the dispensed weight after various dispensing events are evaluated by measuring the weight consecutively.

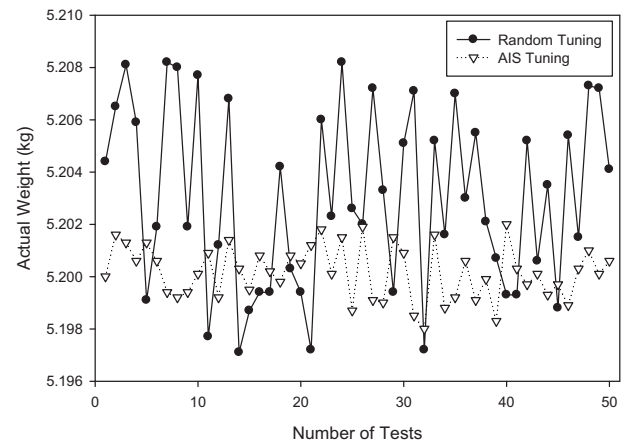
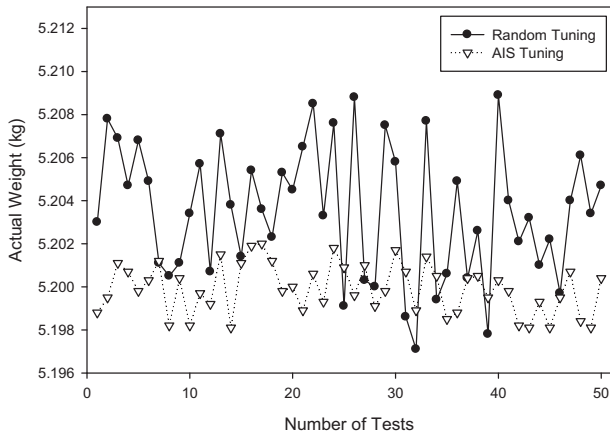
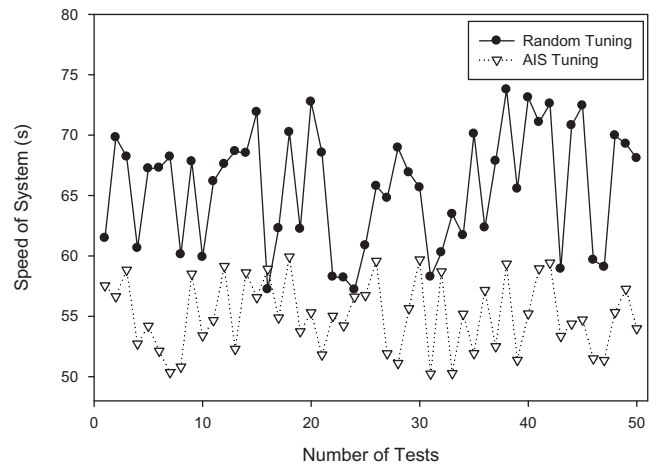

Figure 11 Accuracy test using optimum dispensing parameters for medium A.



**Figure 12** Accuracy test using optimum dispensing parameters for medium B.



**Figure 15** Speed test using optimum dispensing parameters for medium B.

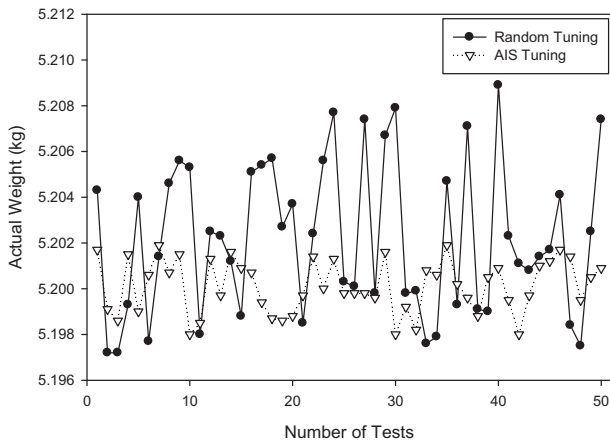

**Figure 13** Accuracy test using optimum dispensing parameters for medium C.

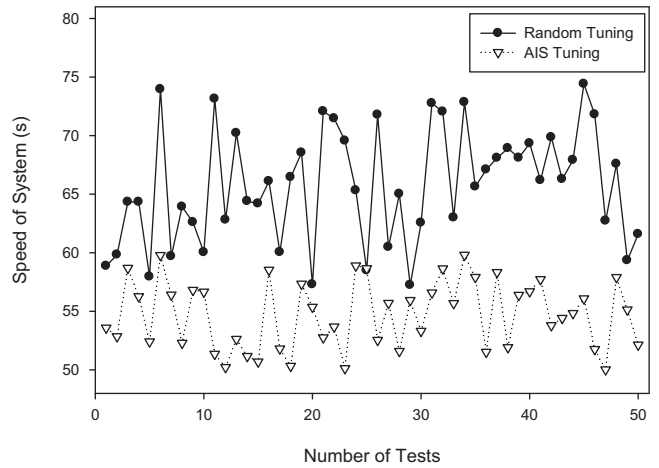

**Figure 16** Speed test using optimum dispensing parameters for medium C.

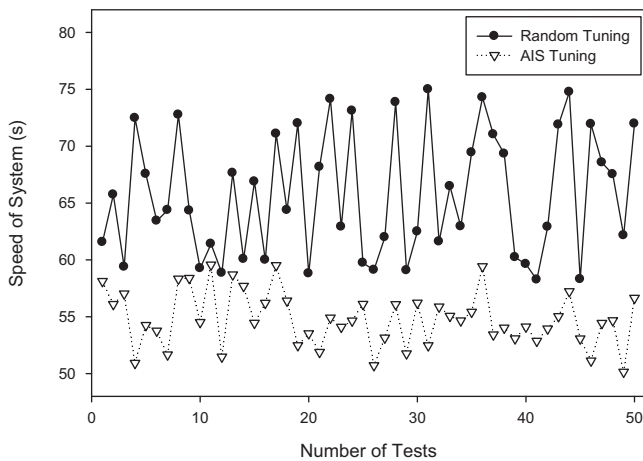

**Figure 14** Speed test using optimum dispensing parameters for medium A.

The steps for the accuracy and speed test with PWM are as follows:

- Step 1: Weight to dispense: 5.2 kg.
- Step 2: Set point for Big Flow to Small Flow: last 300 g.
- Step 3: Set point for Small Flow to PWM Pulse: last 50 g.
- Step 4: Set point for PWM Pulse to Spit Pulse: last 10 g.
- Step 5: PWM coefficient: 1.
- Step 6: Spit coefficient: 2000.

By applying the dispensing sequence using the optimum dispensing parameters (upon utilizing AIS dispensing parameter fine tuning), a consistent accuracy of 5.2 kg  $\pm$  2 g is achieved. Result of the reproducibility obtained for a 5.2 kg batch with comparison to random tuning is displayed in Figs. 11–13.

The speed of the dispensing technique using the optimum dispensing parameters is relatively fast. The results displayed in Figs. 14–16 reveal that the total dispensing time,  $T_D$ , is in



the range of 50–60 s for a 5.2 kg batch at an accuracy of  $\pm 2$  g.

## 6. Conclusion

The introduction of an innovative fluid dispensing system with AIS-based dispensing parameter fine tuning has facilitated the system to automatically and optimally configure the dispensing parameters without going through the hassle of manual tuning. Furthermore, the implementation of AIS on the dispensing parameters fine tuning process optimizes the dispensing process for mediums with different viscosity. As far as accuracy and speed are concerned, consistent and desired results have been achieved. An overall speed improvement of 20% was achieved by using AIS tuning over random tuning. In the accuracy test, AIS tuning is 98.2% to the desired weight to dispense. Moreover, users without the technical knowledge of dispensing system can quickly adapt themselves into using the system knowing that the system itself has achieved optimum parameters that enable them to produce good result. In this way, it is possible for inexperienced and experienced users to achieve better dispensing time and accuracy.

## Acknowledgments

The authors would like to thank The Ministry of Higher Education Malaysia for the financial support under Fundamental Research Grant Scheme No. FRGS/2010/FKEKK/TK03/1-F0085.

## References

- Bowler, P., 1995. Pulse width modulation for induction motor drives. In: Proceedings of the 1st IEEE International Caracas Conference on Devices, Circuits and Systems, Caracas, Venezuela.
- De Castro, L.N., Timmis, J., 2002a. Artificial immune systems: a novel paradigm to pattern recognition. In: Corchado, J.M., Alonso, L., Fyfe, C. (Eds.), *Artificial Neural Networks in Pattern Recognition*. SOCO-2002. University of Paisley, UK, pp. 67–84.
- De Castro, L.N., Timmis, J., 2002b. *Artificial Immune Systems: A New Computational Approach*. Springer-Verlag, New York.
- De Castro, L.N., Zuben, J.V., 2002. Learning and optimization using Clonal Selection principle. *IEEE Trans. Evol. Comput. Special Issue Artif. Immune Syst.* 6, 239–251.
- Foulds, I.G., Johnstone, R.W., 2005. A pulse width modulation controlled bistable micro electro mechanical system. In: CCECE05, 18th Canadian Conference on Electrical and Computer Engineering, Saskatchewan, Canada.
- Kepler, T.B., Perelson, A.S., 1993. Somatic hypermutation in B cells: an optimal control treatment. *J. Theor. Biol.* 164, 37–64.
- Pöschel, W., Engel, R., 1998. The concept of a new primary standard for liquid flow measurement at PTB Braunschweig. In: FLO-MEKO '98, 9th International Conference on Flow Measurement, Lund, Sweden.
- Sim, E.Y.S., Koh, S.P., Tiong, S.K., Yap, B.K., 2009. An automated gravimetric and PWM based fluid dispensing system with GA parameter fine tuning. In: ICRA 2009, 4th International Conference on Autonomous Robots and Agents, Kobe, Japan.
- Steger, R., Koltay, P., Birkle, G., Strobel, T., Sandmaier, H., Zengerle, R., 2002. Two-dimensional array of piezostack actuated nanoliter dispensers. In: Actuator 2002, 8th International Conference on New Actuators, Bremen, Germany.