

## Part II

# Solutions for Sustainability-Driven Development of Manufacturing Technologies

*Dr.-Ing. Fiona Sammler, Institute for Machine Tools and Factory Management, TU Berlin, Germany*

*Dr.-Ing. Nils F. Nissen, Fraunhofer Institute for Reliability and Microintegration, Berlin, Germany*

At the core of sustainable manufacturing is what happens on the factory floor. While many other aspects—such as linking and planning production steps, connecting different players and production sites around the globe, or analysing the sustainability effects of the choices we make—are essential in moving in the direction of sustainability, we still need improvements and innovations at the level of the individual machine tool and manufacturing process.

The sustainable factory floor is by nature more diverse and complex than traditional manufacturing since it needs to be adaptable according to the geographical location, the skill level of employees, the locally available materials and resources, and the individual workers' wellbeing. This chapter focuses on the development of sustainable machine tools and manufacturing processes for the production of industrial goods, which when scaled up, can impact the design of a factory floor. Of course, the goal of sustainable manufacturing processes is to allow a higher value creation with reduced resource consumption.

Whilst the general focus in the production industry remains on the reduction of costs and the production of high quality goods, a higher priority has been ascribed to the overall environmental, economic and social impact of the production process. However, incorporating the solutions developed into an industrial setting has thus far been limited to individual measures, with various countries responding quite differently to the challenge of sustainable manufacturing all the while. Significant barriers persist in hindering the development and implementation of sustainable manufacturing processes. In particular, barriers related to high costs, a lack of availability of funds for green projects, a lack of support from leaders and a lack of standardisation still represent the status quo. In pursuit of the adoption of sustainability-driven manufacturing solutions thus, a clear, tangible advantage for the production industry has to be introduced. Such an advantage is found in increased consumer interest in the sustainability factor, an advantage on account of government levies or cost savings in the long-term due to better recycling options.

Overall, it is essential that the use of renewable resources for the production of goods be favoured. This is however quite often not fully realisable given the simultaneous necessity of achieving highest quality production standards in series

production. When using non-renewable resources, reconfigurability and re-manufacturing must constitute the focus on a much larger scale. The first contribution of this section of the book presents a vision for the future of the machine tool industry in the form of a LEG2O machine tool system. It is a machine tool made of passive and smart building blocks with integrated sensor nodes and can be built according to the demand of a certain product, process, factory, worker skill level or location. The high level of mass customization in today's production industry can therefore be achieved whilst using a defined level of resources without the need for additional investment.

Whilst significant progress has been made in addressing the environmental dimension of the triple bottom line, for example, through the use of new, lightweight materials such as carbon fibre reinforced plastics and other composite materials which have found application in the automotive, aeronautical and machine tool industries, it is the social dimension which must likewise consume our full attention in the future. This can take the form of developing technologies which allow organisations, particularly in developing countries, to create a higher level of value creation to strengthen their manufacturing industry and thus their ability to cater to the needs of the next generation. An example of such a technology is discussed in the second contribution of this chapter in the form of the recently developed Accuracy Increasing Add-On System (AIAS).

The final contribution presents a solution for the energy and cost intensive cooling of machining processes, a necessary intervention in order to avoid the overheating of tools and equipment in a large proportion of cutting processes. The development of an internally cooled turning tool, which allows for the cooling of the tool without cooling lubricant contacting the workpiece, opens up new possibilities for saving on cooling lubricant. This in turn increases the ease of chip recycling, the reduction of energy required per part produced, and from a social point of view, the avoidance of skin irritations due to worker contact with the hazardous cooling lubricant.

To summarise, a strong requirement on the part of the production industry lies in developing solutions and acting responsibly with regards to the triple bottom line. Allowing developing countries to build up their own indigenous manufacturing industry is key to combatting poverty and, as such, solutions must be developed to help the constituents of the developing world help themselves. Such local production networks are not to be seen as competition to the import of goods from developed countries. Instead, they form the basis for deepening the relationships. At the same time, the equipment demands in developed countries are changing rapidly, in contrast to the traditional circumstances wherein production equipment changed very gradually over time. The contributions in this chapter give individual examples of such ideas, with the aim of allowing the reader to develop one's own thoughts on how exactly today's manufacturing industry can and must change in the upcoming years.

# Sustainable Solutions for Machine Tools

**Eckart Uhlmann, Klaus-Dieter Lang, Lukas Prasol, Simon Thom, Bernd Peukert, Stephan Benecke, Eduard Wagner, Fiona Sammler, Sebastian Richarz and Nils F. Nissen**

**Abstract** Environmental, economic and social changes of any significant proportions cannot take place without a major shift in the manufacturing sector. In today's manufacturing processes, economic efficiency is realised through high volumes with the use of specialised machine tools. Change in society, such as in the form of mobility and digitisation, requires a complete overhaul in terms of thinking in the manufacturing industry. Moreover, the manufacturing industry contributes over 19 % to the world's greenhouse gas emissions. As a consequence of these issues, a demand for sustainable solutions in the production industry is increasing. In particular, the concept of "cost" in manufacturing processes and thus the "system boundaries" within the production of the future has to be changed. That is, a great number of aspects to the machine tool and production technology industries can be improved upon in order to achieve a more sustainable production environment. Within this chapter, the focus lies on microsystem technology enhanced modular machine tool frames, adaptive mechatronic components, as well as on internally-cooled cutting tools. An innovative machine tool concept has been developed recently, featuring a modular machine tool frame using microsystem technology for communication within the frame, which allows for a high level of flexibility. Furthermore, add-on upgrading systems for outdated machine tools—which are particularly relevant for developing and emerging countries—are poised to gain in importance in the upcoming years. The system described here enables the accuracy of outdated machine tools to be increased, thus making these machine tools comparable to modern machine tool systems. Finally, the cutting process requires solutions for dry machining, as the use of cooling lubricants is environmentally damaging and a significant cost contributor in machining processes. One such solution is the use of internally cooled cutting tools.

---

E. Uhlmann (✉) · L. Prasol · S. Thom · B. Peukert · F. Sammler · S. Richarz  
Institute for Machine Tools and Factory Management, TU Berlin, Berlin, Germany  
e-mail: uhlmann@iwf.tu-berlin.de

K.-D. Lang · S. Benecke · E. Wagner  
Research Center for Microperipheric Technologies, TU Berlin, Berlin, Germany

N.F. Nissen  
Fraunhofer Institute for Reliability and Microintegration, Berlin, Germany

© The Author(s) 2017  
R. Stark et al. (eds.), *Sustainable Manufacturing*, Sustainable Production,  
Life Cycle Engineering and Management, DOI 10.1007/978-3-319-48514-0\_4

**Keywords** Flexible machine tools · Modular frames · Microsystem technology · Outdated machine tools · Adaptronic add-ons · Dry machining

## 1 Introduction

The manufacturing industry influences economic, ecological and social development worldwide. Industrial energy consumption has been increasing in most developed and undeveloped countries over the last decades. Nearly a third of the worldwide energy consumption as well as CO<sub>2</sub>-emissions are related to the production industry (International Energy Agency 2007). Furthermore, an increasingly mobile and digital society is calling for new customised technical solutions to a diverse array of products both anytime and anywhere.

In pursuit of sustainable change in the manufacturing industry, it is necessary to develop innovative solutions for machine tools as well as for production processes. To meet the demands of the global market on top of that, it's important to identify "new ways" for sustainable solutions for machine tools which may serve to generate a long-term effect in the production industry.

To impact the sustainability of machine tools, machine tool frames, in particular, must constitute a central focus. Machine tools are "static" in general. Current flexible manufacturing systems are able to handle several production situations. As a result, they are rarely fully exploited and usually "over engineered" and therein require a lot of engineering hours and raw materials. They start their product life with a negative environmental burden as a result.

Even flexible manufacturing systems are not suitable for handling the batch size "one" and therefore short development times are required that can be adapted to new requirements. These challenges are the main drivers for the future development of the machine tool industry, taking into account increasingly scarce resources at hand.

The increase in accuracy of machine tool frames, the usage of mechatronics regarding the accuracy of axes, as well as the "sustainable engineering" of solutions and recycling of components and equipment, constitute the main parts of the research work presented in this chapter. By applying modular machine tool frames using microsystem technology, the accuracy of these applications has been increased significantly. Modular machine tool frames can be used again and again and remain automatically up to date. Furthermore, the realisation of the product batch size "one" is possible if required. Through the use of adaptronic components, the accuracy of machine tools is increased, meaning older machine tools can stay abreast of latest developments. These adaptive components can furthermore be used in modular machine tool frames. By applying innovative tools for machining, sustainable solutions for machine tools are thus being identified from several different angles.

## 2 Technological Concepts

### 2.1 *Microsystems Technology*

Microelectronics constitutes the core of the up-and-coming paradigm “Industrie 4.0” and “cyber physical systems,” including supply chains and manufacturing environments. Small distributed systems such as wireless sensor nodes (WSN) and -systems (WSS) are mainly applied within safety systems, control systems (closed loop regulatory systems, closed loop supervisory systems, open loop control systems), monitoring systems (alerting systems, information gathering systems), e.g. the monitoring process of production equipment, yet also feature logistics support with electronic functions beyond radio-frequency identification (RFID) (Schischke 2009). The recent progress in the research of WSN application meets the requirements of manufacturing environments such as functional integrity, robustness, miniaturization and low energy consumption, as well as the more general industrial requirements of low cost, interoperability, resistance to noise and co-existence, self-configuration and organisation, scalability, data allocation and processing, resource efficient design, adaptive network optimization, time synchronization, fault tolerance and reliability, application specific design, and secure system design (Zurawski 2009). The use of WSN poses ecological questions that need to be balanced efficiently on the part of the hard- and software designers involved by means of customised WSN architecture and a WSS layout which closely follow the functional application or use-case scenario whilst at the same time maintaining a low environmental footprint.

WSN for industrial environments can be deployed remotely from the actual point of measurement using complex data acquisition techniques for gauging, constrained by environmental noise. Autonomous WSNs are applied physically in the peripheral environment of the wired grid without direct cable access. Hence, these systems enable sensing tasks at frequently changing or remote locations that cannot be accessed by conventional measurement equipment (Ovsthus and Kristensen 2014). Basic WSN **hardware design** features a central processing unit (microcontroller) that is linked to memory, a communication unit (radio frequency (RF) transceiver including an antenna), sensor units, an independent energy source (energy harvester or battery) and, optionally, a human-machine-interface (HMI).

In the case of distributed WSNs, the **energy efficiency** is a critical factor, as they carry limited energy storage. While wired concepts allow the focus to be on the quality of service (QoS), wireless concepts aim to achieve primarily power conservation at the expense of, for example, lower throughput or higher transmission delay. To meet the requirements of energy efficiency while conserving reliable messaging, industrial settings call for an application of specific communication technologies including RF interference problems, more complex circuitry, individual software algorithm design, WSN topology, such as star or multihop meshed communication network and costs. An overview of radio frequencies involved is given in (Rault et al. 2014). Data losses and communication reliability that appear

in industrial settings suffer from noise, co-channel interferences and multipath propagation resulting from such typical obstacles as stationary or moving objects (noise) and RF interferences from other devices (Ovsthus and Kristensen 2014).

Wireless **sensor networking** technology in terms of protocols and standards for the so-called industrial internet of things (IIoT) attempt to combat the obstacles mentioned (Hu 2015). Based on the IEEE 802.XX standard, the derivations ISA 100 and wireless HART are used for applications in process automation since they are considered to be energy efficient, robust and reliable. ZigBee (IEEE 15.4) is considered to be geared towards low energy consumption, low cost and security. As a middleware publishing/subscribing protocol, the Message Queuing Telemetry Transport (MQTT) protocol is being considered for reliable messaging due to its lightweight architecture (Sheltami et al. 2015).

With greatly reduced energy consumption, it is also becoming feasible to employ efficient battery and **energy harvesting technology** as decentralised energy sources. Primary batteries offer the highest performance with about  $3000 \text{ J/cm}^3$ . Manufacturing environments offer high potential for broadband vibration, fluidic or thermoelectric energy harvesting sources at about  $40 \mu\text{W/cm}^2$  to  $1 \text{ mW/cm}^2$ . In the trade-off, high performance computing and high sampling rates stand up against low-power and miniaturised applications (Beeby 2006, Gungor and Hancke 2009; Elvin and Erturk 2013).

A broader investigation of the trade-off between **environmental** benefits and the negative impact of the additional microsystems including wireless sensor nodes (WSNs) was conducted in the German technology assessment study “Innovations- und Technikanalyse Autonomer Verteilter Mikrosysteme” (Autonomous Distributed Sensor Systems) (Schischke 2009). Qualitative results show that primary effects, e.g. resource consumption or recycling, are mainly negative, while indirect impact, such as production efficiency, are positive. Moreover, the long-term compatibility between the different lifecycles and concepts of machine tool components and electronics remain an interesting research topic.

To date, a link between the impact of microsystems on component level and **modularity** leading to further improvement recommendations on the system level remains missing. The question of how to support the designer of electronic systems with easy-to-use indicators while addressing sustainability issues has been addressed by (Wagner et al. 2016). The design methodology developed serves to connect common electronic components to their contained materials and selected impact types like cumulative energy demand or recyclability. From the system assessment standpoint, there is a need for evaluations of the trade-off between more functionality and more resource impact for 25+ years use time.

## 2.2 Reconfigurable Machine Tools

The design process of machine tools represents a major investment in tangible and intangible resources for machine tool manufacturer and consumer. Lead times are

especially high in the case of individualised machine tools and assembly lines. From a sustainability perspective, long lifecycles of machines of over 25 years are difficult to manage, given the volatility of product variants and low batch sizes of today's global market. As the production of machine tools has high relevance in the world economy (Verein Deutscher Werkzeugmaschinenfabriken e.V 2015), machine tool manufacturers are therefore interested in shortening delivery times, increasing flexibility and reducing material consumption in pursuit of ultimately offering superior solutions to customers.

Moving on to machine tool frames, these elements provide fundamental structural support for every machine tool. Their production requires expensive engineering, testing and high precision manufacturing. As conventionally casted or welded structures, machine tool frames are limited in terms of reconfiguration and cannot be altered after manufacturing. This restricts the reuse to configurations which were initially incorporated into the planning on the part of the engineers.

As the public is becoming increasingly aware of the issue of sustainability, sustainable product manufacturing has become a selling point of its own right. This is true for products manufactured with machine tools, but also for machine tools as products themselves. Previous manufacturing paradigms aimed at producing homogenous products at highest qualities and lowest costs. Nowadays, consumers are demanding the production of individualised goods. This manufacturing paradigm is called mass customisation, which among other developments, most recently led to research on reconfigurable machine tools (RMT) within reconfigurable manufacturing systems (RMS).

**Reconfigurable Machine Tools** Reconfigurable Manufacturing was defined by Koren et al. (1999), and pointed towards the need for scalable and adaptable manufacturing equipment. One solution to enable the necessary shifts in manufacturing paradigms is the introduction of RMT, made from different modules. With this concept, the foundations of the modular design of machine tools were studied extensively and compiled by Ito (2008). Pioneer work in the modularity of machines was done by Herrmann and Brankamp (1969), who defined the idea of Building Block Systems (BBS). Since then, many research and industrial activities regarding modularisation and reconfiguration in manufacturing (tool design) have been carried out, some of which have found their way into industrial application.

Mori and Fujishima (2009) have presented designs of reconfigurable CNC machine tools addressing the design concept, machine tool configuration and application examples, respectively. The design of the machine tools allowed for selecting a number of axes by the individual axis modules and reconfiguration of the spindle in horizontal and vertical directions. Wulfsberg et al. (2013) give a summary of the concepts developed in the context of modularity in small machine tools for micro-production. The design measures are associated with those of conventional machine tool components for the development of modular systems. Scalability of the working area, namely the change in size of the working area, was achieved within the research work presented. Abele and Wörn (2009) describe a catalogue of components developed for reconfigurable machine tools in the project METEOR. A new approach was developed with the "Reconfigurable Multi

technology Machine tool” (RMM) concept that enables the integration of multiple production functions in a single workspace. Most related to sustainability issues, the German project LOeWe (German acronym for Life cycle Oriented development of machine tools) aimed at designing a modular machine tool capable of serving as the basis for different manufacturing processes by including aspects like use-phases and the corresponding life-cycles (Denkena et al. 2006).

With a higher degree of modularisation, challenges have arisen particularly for modularised machine tool frames due to the decreased stiffness which results. The mechanical module interfaces represent serial compliances, reducing the overall rigidity of the given structure assembled. Of course, rigidity is one of the key factors for high productive manufacturing. At the same time, however, the stability of a machine tool mainly depends on a sufficient level of dynamic stiffness of the frame. A common approach for improving the dynamic behaviour is found in the inclusion of actuators and control loops within machine tool structures for the purpose of enhancing damping or for decreasing the dynamic compliance. A building block system for modular machine tool frames therefore requires individualised sensors and actuators.

In addition to sensor technology (see section Microsystems technology), actuators are of great interest when designing for sustainability. As the paradigm of sustainable product design has emerged over the last decades, the design of actuator systems needs to take multifaceted aspects of sustainability into consideration accordingly. This includes avoidance or at least reduction of energy consumption, the substitution of hazardous materials with environment-friendly ones, and low-cost solutions for the production of actuators, leading to solutions for Green Engineering and Manufacturing (Dornfeld 2012).

Various research work on this topic exists, e.g. analysing the energy efficiency of hydraulic, pneumatic and piezoelectric actuators and improving on those actuators (Eriksson 2007; Harris et al. 2014). Existing approaches for achieving higher efficiency vary depending on the actuating principles involved. The most common approach for improving sustainability has turned out to be downsizing, featuring a combination and reconstruction of systems. A combination of different actuation principles, on the other hand, improves the energy efficiency of actuators and combines the advantages of both principles. In this context, for example, hybrid drives are being designed which provide lower energy consumption than regular linear motor direct drives and combine their higher speed and accuracy with the higher damping of screw drives (Okwudire and Rodgers 2013). Chen et al. (2014) present the design of a novel three-degrees-of-freedom linear magnetic actuator which increases the damping and static stiffness of flexible structures during machining. The actuator uses electromagnetic materials which allow larger load capacity and almost no hysteresis compared to piezo and magnetostrictive materials such as Law et al. (2015) report on a novel electro-hydraulic actuator that attenuates and isolates ground motion to keel dynamic excitations transmitted to machine tools below permissible levels. The analysis of optimal placement of actuators can also lead to increased efficiency and thus has to be taken into consideration (Okwudire and Lee 2013).



Applying this principle into the context of RMT, sustainability benefits are anticipated by designing building block systems using tiered technological architectures. Passive lightweight modules can be used to provide structural integrity. Meanwhile, adaptable and reusable sensor technology can increase the smartness of the building block system and improve the overall machine tool frame performance in combination with actuating modules and closed loop controls algorithms.

### ***2.3 Adaptronics in Machine Tools***

One of the major limiting factors for the machining quality at high cutting speeds is the static and dynamic behaviour of a machine tool (Ast et al. 2007). The challenge of achieving high static and dynamic stiffness and implementing lightweight design requires adaptronic solutions, which allow for the direct influence of the structural properties of mechanical structures. Adaptronic systems can be integrated into machine tools for different purposes, e.g. active error compensation, active vibration control and active chatter avoidance. The integration of adaptronic systems into machine tools stands as a (key) enabler for achieving higher machining performance as well as for reducing resource consumption, emissions and costs in manufacturing.

A key example of such adaptronic systems is found in dual-stage feed drives. **Dual-stage feed drives** designed for the purpose of allowing high precision positioning over a large workspace on conventional machine tools, fast tool servos (FTS) (e. g. piezoelectric actuator driven flexures) are connected in a series with a machine tool drive in a so-called dual-stage feed drive (DSFD) setup. Woronko et al. (2003) implemented a piezo-based FTS for precision turning on conventional CNC lathes. The results show that the tool positioning accuracy as well as the surface quality could be increased. Elfizy et al. (2005) investigated DSFD for milling processes in pursuit of enabling high precision positioning over a large workspace. In that process, a two-axis flexure mechanism featuring piezoelectric actuators is connected in a series with the machine tool drive stage. The tracking error for sinusoidal profile milling was reduced by approximately 80 % compared to a single stage feed drive. In addition, Drossel et al. (2014) show versatile applications of adaptronic systems in machining processes. FTS systems are currently applied in the form of honing processes for the purpose of increasing the positioning accuracy and for reducing vibration of the tool. The achievable shape accuracy could be therein improved to  $\pm 3 \mu\text{m}$  and the surface roughness decreased to a reduced peak height of  $R_{pk} = 1.7 \mu\text{m}$  (Drossel et al. 2014).

#### **Active vibration control**

Although active vibration control is not a new concept, a recent development in the field of chatter avoidance for machine tools by means of active damping was discussed by Brecher et. al. (2013). Hömberg et al. (2013) investigated the influences on chatter and solutions for chatter avoidance to improve the efficiency of

production of high quality parts at higher removal rate. Ast et al. (2007) integrated an adaptronic rod in a lightweight structure of a lambda kinematics machine tool in order to overcome vibrations at the tool centre point (TCP), which were identified as a limiting performance factor. Moreover, the active component is designed in a modular manner in such a way that it is transferable to comparable machine tools.

**Structure integrated adaptronic components** were introduced by Brecher and Manoharan (2009). These devices can compensate deformations of slider structures. Quasi-static and dynamic compensation can be designed for translational and/or rotational axes (Abele et al. 2008; Aggogeri et al. 2013). The modularity is addressed by designing a single unit, which can be used as an active workpiece holder or as a device mounted on a spindle for vibration control (Aggogeri et al. 2013). Chen et al. (2014) presented a smart way of orienting electromagnetic actuators by obtaining two translational and one rotational degree of freedom for an active workpiece holder. Real time compensation of geometric deviations is provided by employing rigid body simulations implemented in the form of an observer in CNC-control (Denkena et al. 2014).

**Control strategies** With developments in control theory, sophisticated and ‘easy to implement’ control strategies have evolved over time. To that end, Tiwari et al. (2015) presented an investigation of the application of artificial intelligence techniques, such as fuzzy logic, neurofuzzy, genetic algorithm, genetic programming and data mining in the mechanical engineering domain. An Artificial Neural Network (ANN)-based system of identification and control of dynamic systems was proposed in the late 1980s and early 1990s (Narendra and Parthasarathy 1990). Thereafter, many applications based on neural network control were developed. For instance, a control based on two neural networks with a radial basis function was proposed by Liu and Fuji (2014) for precise positioning of a system with piezoelectric actuators.

### **Upgrade on demand**

The requirements on machine tools depend on and change with the manufacturing task at hand, which is a challenge in a low batch size production environment, see Fig. 1. Machine tools which do not meet the required properties are considered outdated and need a technical overhaul in order to produce productively.

In the machine tool sector, retrofitting is a common principle in the pursuit of reviving outdated machine tools. Retrofitting is primarily understood as steady modification of an existing machine tool and comprises activities such as turning-off or replacing components of machine tools to save energy, or the exchanging out of key wear parts (Gontarz et al. 2012). These activities target a machine tool, its auxiliary systems or the machining process itself.

Among the concept add-ons presented here are optional equipment for upgrading specific functions of machine tools in a flexible manner. The conceptual distinction between retrofit and upgrade by means of add-ons is that the application of add-ons is not permanent but flexible to the required specifications. Sharing add-ons for a pool of machine tools thus enables a production environment to be more resource efficient.

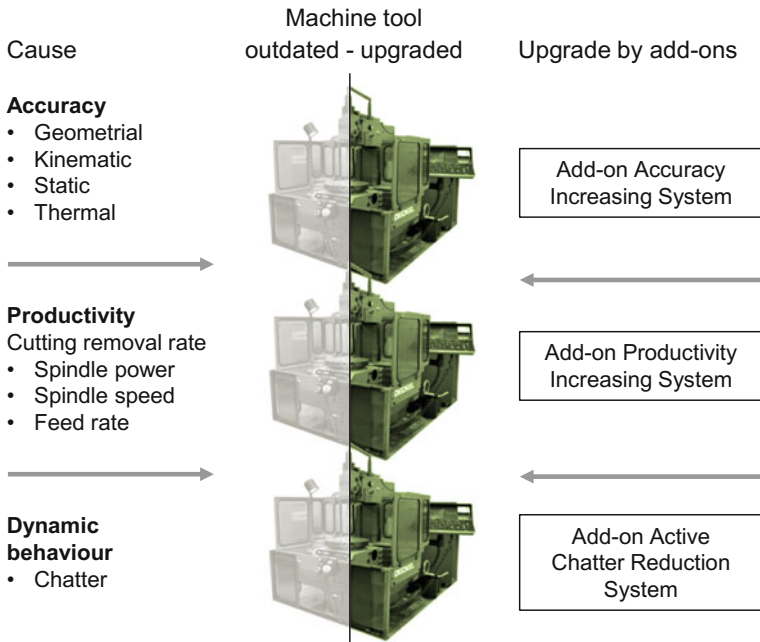

Fig. 1 Concept of machine tool upgrade by add-ons

**Easy-to-install** capabilities are a necessary feature of add-ons in order to apply the systems in a flexible manner. In addition to the mechanical fixing (e.g. by releasable fastener) on a machine tool, the add-ons applied should be independent of the machine tool control thus allowing the upgrading of a wide range of machines.

## 2.4 Dry Machining

Whenever cooling liquid (CL) is used in the production process, tools and workpieces are cooled directly and the friction between the two of them is reduced. This leads to improved tool life and a better workpiece surface quality at the same time. Another advantage is that all chips are washed out of the working area (Klocke and Eisenblatter 1997). If CL is employed in the production process, the following disadvantages have to however be accepted—usually, the chips are contaminated with CL and must be cleaned in downstream installations such as centrifuges and briquetting machines. Moreover, occupational-safety measures have to be applied in order to limit CL’s harmful effects to workers’ health (Klocke and Eisenblatter 1997; Byrne et al. 2003; Heisel and Lutz 1993a, b).

**Dry processing** is a production technique characterised by low-power consumption and lean manufacturing chains, as there is no need for the production, monitoring and disposal of cooling lubricants (Ward et al. 2016). This both saves on downstream cleaning and eliminates potential working time lost due to sickness caused by contact with cooling lubricants. However, no cooling of the cutting edge takes place, and the positive effects of lubrication in an interrupted cutting process are likewise lost. In a worst-case scenario, a switchover to dry processing will involve downward revision of the wet processing cutting parameters, which means that the savings on cooling lubricants and the benefits of lean manufacturing processes are offset by a loss in productivity. Alternatively, cooling can be affected with compressed air, solid carbon dioxide or liquid nitrogen (Uhlmann et al. 2012). These alternative cooling agents volatilise in the machining zone, yet their application comes with such high costs that only in exceptional cases do they stand as economically reasonable options (Uhlmann et al. 2012, 2016). Another low-cost tool cooling solution is found in closed internal cooling systems which use a heat sink for dispersing the tool's machining heat in a cooling medium. The accumulated heat in the tool is directed away, and thus is separated from the rise in temperature during actual cutting time.

### 3 Sustainable Solutions

This chapter describes the development of three sustainable production technology concepts as shown in Fig. 2, schematically. The concepts and solutions for sustainable manufacturing technology presented in Sect. 2 require a step-by-step change within this discipline. In this process, the first step to be realised lies in the integration of innovative machining processes into existing machine tools. In the second step, the modularization of machine tool frames is to be realised, taking into account smart microsystem technology and innovative machining processes. In the final step, the upgrading of the machine tools can be undertaken as necessary.

**Internally-cooled tools** Turning tools with closed internal cooling systems must meet a different set of requirements compared to conventional tools. In particular, they must ensure mechanical stability under the temperature range of the deployed cooling medium. An internally-cooled turning tool and cooling periphery was, furthermore, developed within the framework of the work described here.

**LEG<sup>2</sup>O smart building block system** As Koren et al. (1999) stated, RMT are anticipated to contribute significantly to the manufacturing of mass-customised products. Key attributes related to the sustainability of RMT result from delivering the machining purpose when and as needed and from avoiding downtime or underutilization. Although modularization was achieved on the hardware side of machine tools, among various other components in the past, the modularisation of the machine tool frame remains an open question of great relevance. A Smart Building Block System (BBS) for modular machine tool frames is envisioned to overcome technological limitations and to provide a sustainable alternative to the

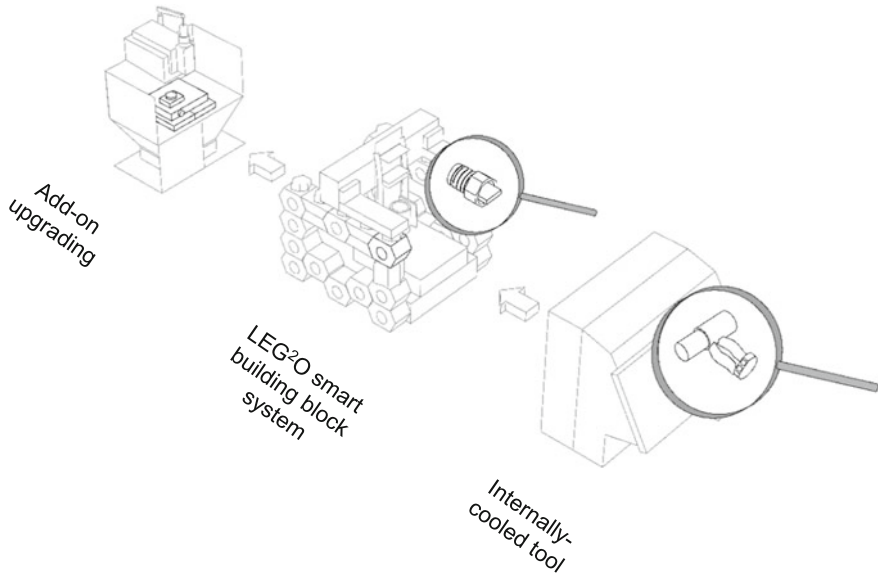

**Fig. 2** Sustainable machine tool concepts—development from the present to the future

design of conventional machine tools. This is achieved by using a tiered technological approach combining microsystem technology (MST) and mechatronic technology (MT).

**Add-ons for outdated machine tools** Compared to current machine tools, outdated machine tools suffer from high positioning deviations and fail to add sufficient value to current production systems (Uhlmann and Kianinejad 2013). Under this concept, this problem is tackled by an upgrade using an Add-on Accuracy Increasing System (AAIS). The add-on systems are used without exchanging essential system components. By upgrading or enhancing the functionality of outdated machine tools rather than replacing them with new machines, valuable resources can be saved (Allwood et al. 2011). The add-on solution developed, furthermore helps to keep outdated machine tools competitive in the contemporary production chain by increasing not only positioning accuracy but also by allowing for active vibration control to reduce chatter (Kianinejad et al. 2016).

### 3.1 Smart Building Block Systems

The technological basis of the LEG<sup>2</sup>O BBS (German acronym for lightweight and accuracy optimised) consists of passive, active and MST enhanced smart building blocks, called modules, with a weight limitation of 30 kg per unit. In accordance with worker safety regulations for manual lifting, each component of the LEG<sup>2</sup>O

BBS allows for manual handling during assembly, maintenance and upgrading with low-level infrastructure (Steinberg and Windberg 2011). Studies on use-cases of these BBS led to the conclusion that for LEG<sup>2</sup>O BBS, most cutting machine tool scenarios are sound (Peukert et al. 2013).

What's more, first order impacts directly associated with LEG<sup>2</sup>O BBS were addressed in a tiered life cycle sustainability assessment (Peukert et al. 2015b). The research revealed clear benefits during the whole life cycle compared to conventional static machine tool frames due to reuse and adaptation of machine tools.

**Passive modules** provide fundamental mechanical properties, e.g. rigidity, to support the core structure of modular machine tool frames. Within the scope of sustainable design, resource efficiency was set as a target during the design phase of the passive module. A bionic-inspired fractal design approach was chosen, resulting in high geometric flexibility with stiff and scalable structures based on two modules with a hexagonal prism shape (Peukert et al. 2015a). These modules were topologically optimised to provide a lightweight and resource-efficient foundation with the necessary rigidity to compete with conventional machine tool frames. Figure 3 shows the development history of the different design stages of passive modules and shows the topologically optimised hexagons with a weight of 6.2 and 12.3 kg, respectively. Yet, on top of advantages in damping behaviour, decreased rigidity and dynamic stiffness are caused by the high number of joints (Uhlmann and Peukert 2015), leading to the need for active modules and compensation.

**Smart modules** The physical instantiation of MST by means of wireless sensor nodes, provides smart functionalities (e.g. orientation sensing) in dedicated passive modules within the frame, or so-called smart modules. Data on module identification as well as parameters related to the physical state of the machine tool frame are shared between smart modules and one centralized receiving unit using wireless communication. The demand for fully autonomous concepts and long-term usage called for a revised catalogue of requirements apart from conventional industrial sensors. As the overall system size of highly miniaturised sensors is dominated by the autonomous energy supply, measures for reducing the average power consumption were identified as crucial aspects of system design (Lambebo 2014). With highly efficient programming routines, e.g. reduced instruction sets and the relocation of dedicated tasks into the base stations, operating times were even further prolonged without the need for battery replacement. However, only through the application of advanced packaging technologies can optimised form factors be

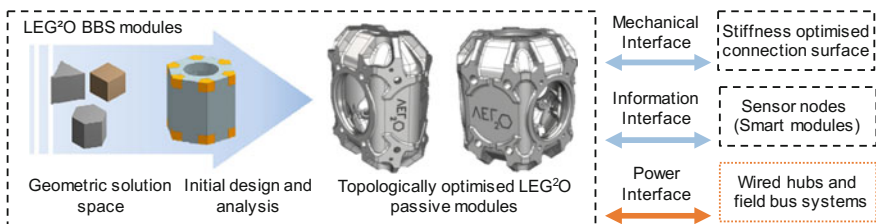
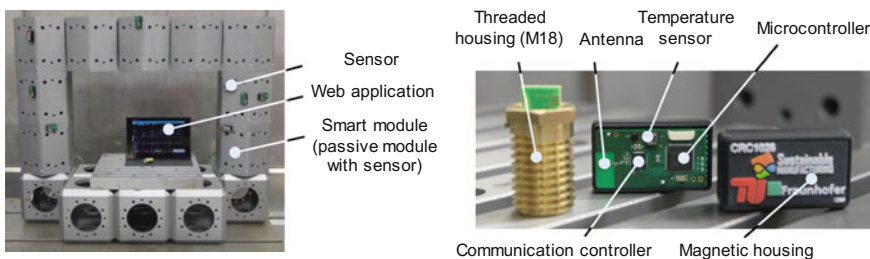

**Fig. 3** Topologically optimised passive modules and interfaces

achieved that allow for the least interference at maximum functional density and long lifetime at the workstation. A combined approach including Flip Chip assembly, surface mount technology and a sequence of embedding processes on panel level was furthermore used to realise a new generation of WSNs. Physical devices demonstrating the fusion of MST hardware with MT (e.g. in a screw) are shown in Fig. 4 with selected functional groups indicated.

**Active modules** are used to compensate for displacements. The control loop of the actuators uses on-line data, transmitted wirelessly by smart modules. Apart from the machine tool dynamic, thermal loads constitute a main cause of inaccuracies with machine tool frames. Hence, the active modules have a control platform manipulated by three separate compliant mechanisms. The compliant mechanisms are driven by the thermal deformation of aluminium bars controlled by thermo-electric modules. The slow nature of thermal deviations allows the usage of solid state relays to power numerous active modules from a single power supply. Hence, additional sustainability benefits can be achieved in comparison to traditional piezo-driven approaches, which require one amplifier per channel. At a simplified level, the construction and usability of this approach, as well as the concomitant sustainability benefits and control of the active module, were analysed (Uhlmann and Peukert 2015). The topology of the mechanism facilitates a self-adapting passive compensation movement at the output platform by change of ambient temperature due to an inherent thermal compensation of approximately  $\alpha_i \approx 2 \mu\text{m/K}$ . The actuator is designed to provide a compensating range of  $\Delta x = 100 \mu\text{m}$  maintaining micrometer accuracy. Figure 5 shows the actuator and experimental results of the closed loop control in a prototypical test structure.

A combined hard- and software infrastructure synchronises all relevant data for the analysis of thermal distortion of the frame as shown in Fig. 6. Additional data sets, e.g. module identification and orientation, are distributed to external devices for visualisation on a tablet PC. A methodology was developed to support the spatial setup of WSNs within the LEG<sup>2</sup>O BBS (Uhlmann et al. 2014). This method supports the optimisation of the relationship between the mechanical structure,



**Fig. 4** Wireless sensor nodes for parameter monitoring of passive LEG<sup>2</sup>O modules—the final technology demonstrator of the sensor fits into a hollow M18 screw



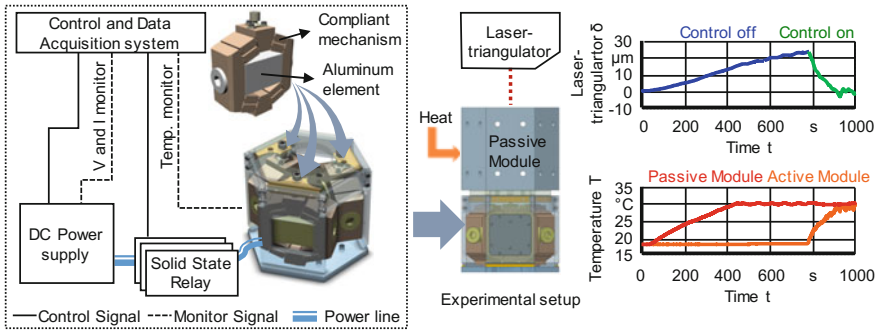

Fig. 5 Active module for compensation of thermal deviations

loading scenario and the number of sensor nodes, and thus helps minimize the utilization of MST.

### 3.2 Add-Ons for Machine Tool Upgrade

Outdated machine tools suffer from high positioning deviations compared to current machine tools and fail to add sufficient value to present production systems (Uhlmann and Kianinejad 2013). Within the scope of the work described here, this technical obsolescence is addressed by an upgrade using an Add-on Accuracy Increasing System (AAIS). The add-on systems are used without exchanging essential system components. By upgrading or enhancing the functionality of outdated machine tools rather than replacing them with new machines, valuable resources can be saved (Allwood et al. 2011). The add-on solution developed helps to keep outdated machine tools competitive in the contemporary production chain by increasing not only positioning accuracy, but also by allowing for active vibration control to reduce chatter (Kianinejad et al. 2016).

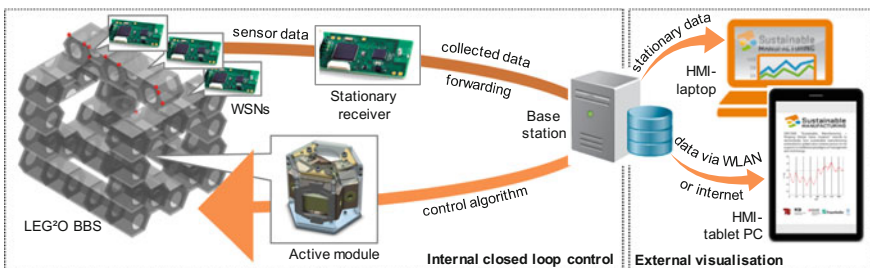
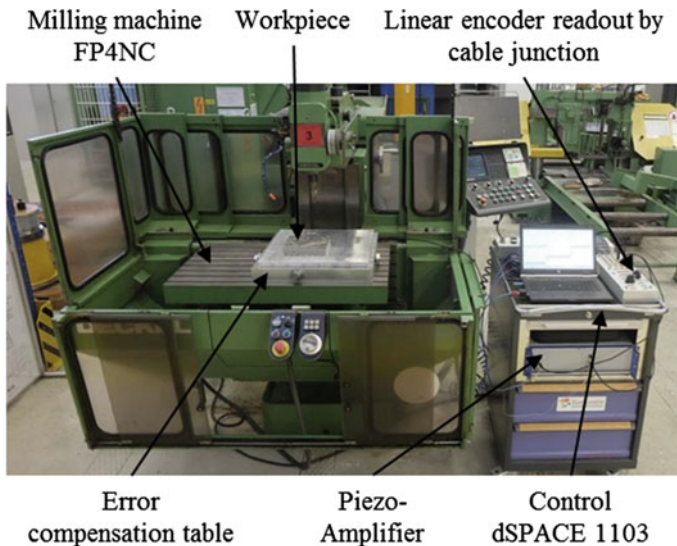

Fig. 6 Concept of the smart modules equipped with MST (WSNs) and IT infrastructure (Base station, HMI)



The energy efficiency for different machining operations of an outdated milling machine and a modern one was compared in (Kianinejad et al. 2015). Though the energy consumption of the outdated machine exceeds that of the newer one, the upgrade of an outdated machine tool presented saves raw materials, energy for material extraction, along with manufacturing energy by not replacing the outdated milling machine with a new one.

**Add-on Accuracy Increasing System (AAIS)** A high accuracy error compensation table has been integrated and tested on a representative milling machine tool, shown as Fig. 7. The FP4NC milling machine, FRIEDRICH DECKEL AG, München, Germany is run by a GRUNDIG Dialog 4 control, so that compensation by control unit is not possible. Sensors of the add-on system can measure a significant portion of static, dynamic, and kinematic inaccuracies. These measurements are used, together with a feedback control mechanism to correct the errors by means of piezoelectric actuators. The add-on error compensation table is run by separate control hardware (dSPACE 1103) and does not share the control unit of the machine tool, making the solution developed both modular and independent of the type of machine. In order to use the error compensation table depending on the respective manufacturing tolerances and to allow sharing with different machine tools, the main challenge with the integration of an error compensation table is to provide easy-to-install capabilities. These capabilities are achieved by independent control, as only one interface is required to the machine tool for sensor readouts, along with a screw connection of the table, see also (Kianinejad et al. 2016).



**Fig. 7** Test setup of a upgraded milling machine FP4NC, FRIEDRICH DECKEL AG, München, Germany

**Fig. 8** Error compensation table (clamping plate removed)

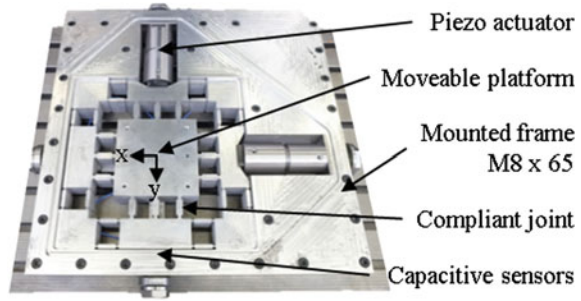

The error compensation table corrects the relative position between workpiece and tool in real time and provides compensation in two perpendicular axes in the horizontal plane (see Fig. 8). A capacitive sensor mounted in the frame is used in each direction to detect the motion of the platform with respect to the frame. Along with measuring the quasi-static position, these sensors also measure the dynamic movement of the platform. Together with the piezo actuators and control designed, active damping is also provided by AAIS.

The piezo actuators are pre-stressed by a housing in order to protect them against forces. The nominal stroke of the piezo actuators  $s_A = 125 \mu\text{m}$  is reduced by the applied pre-stress and voltage of amplifiers, so that AAIS can provide a compensation of  $s_{AAIS} = 55 \mu\text{m}$  in each of the axes.

To overcome the problem of stick-slip and backlash, the error compensation table is designed to be monolithic, featuring compliant joints which provide high stiffness up to  $k_z = 100 \text{ N}/\mu\text{m}$  in the vertical direction (Kianinejad et al. 2016). In order to provide high strain by low stress in the compliant joints, aluminum alloy (AW7075) was chosen due to its high ratio of strength to elastic modulus.

A look-up table is generated containing the repeatable error by initial measurements on the linear positioning of the machine in the x and y axes. By feeding the look-up table with the reference position (x, y) of the linear encoders of FP4NC, FRIEDRICH DECKEL AG, München, Germany a reference signal is generated. This reference signal is then fed to the control of the xy-table for tracking.

Figure 9 shows the static positioning test performed by a laser interferometer on the x axis of FP4NC with and without the AAIS and also compares the data to the positioning accuracy of a modern machine tool, a DMU50, DMG MORI AG, Bielefeld, Deutschland produced in 2008. It can be seen that AAIS improves the positioning accuracy significantly.

### 3.3 Internally-Cooled Tools

The **tool design** of turning tools was reconsidered when taking the requirements and conditions of an integrated closed-loop cooling system for turning tools into

**Fig. 9** Positioning deviations of the x-axis

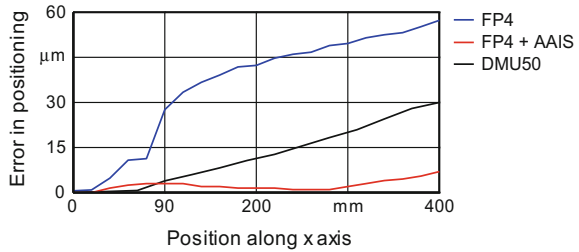

consideration, e.g. cooling medium temperatures from  $-210$  to  $+40$  °C. As a result, topology optimised tool geometries were simulated and investigated. The resulting tool design concepts were assessed by taking into account the weight, stiffness, and the level of integration (Uhlmann et al. 2014). The position of the cutter should likewise avoid shifting during the operation of the cooling system, as this otherwise results in marked variations in the geometry of the finished components. To manage this, the cooling medium channels are integrated into the turning tool holder body and are decoupled from its support structure. Manufacturing of flow-optimised cooling channels is difficult, thus selective laser melting is used for fabrication of the tool holder, see Fig. 10.

**Comparison of different cooling strategies** A comprehensive analysis of three different cooling methods compared to a dry machining process was carried out with a variation of different cutting speeds  $v_c$ :

- Dry machining with an internally-cooled tool with a water-ethanol mixture as process coolant
- Dry machining with an internally-cooled tool with liquid nitrogen as process coolant
- Flood cooling

The energy demand of these cooling methods compared to a dry machining process is given in Fig. 11. The use of liquid nitrogen as a process coolant improves the tool lifetime by at least 50 %. However, due to the temperature influence of the coolant, the TCP shows a displacement of up to  $dT = 0.2$  mm. The total energy

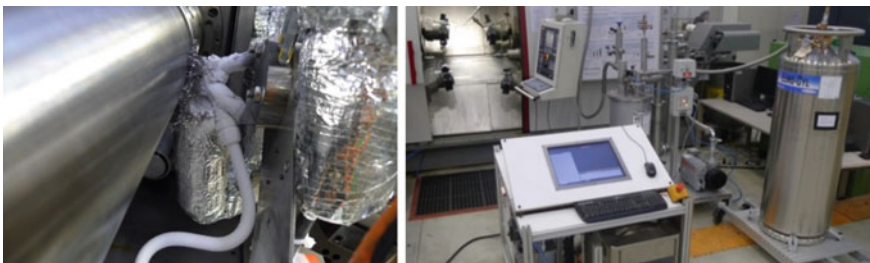

**Fig. 10** Internally-cooled turning tool and cooling periphery

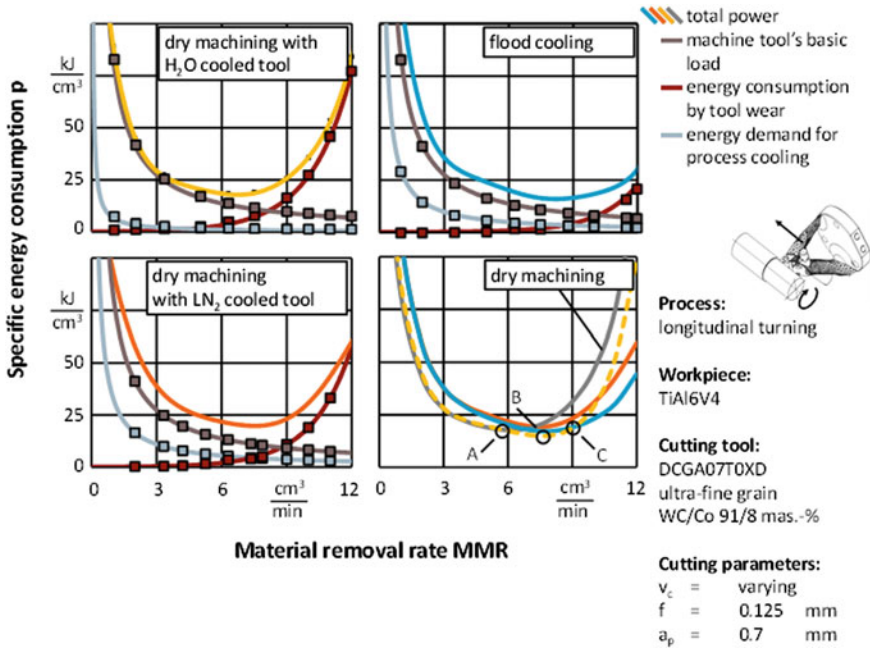

**Fig. 11** Energy demand of cutting processes with different cooling methods

demand is comparable to flood cooling. Using the water-ethanol mixture, the tool lifetime can be improved by at least 40 % while the TCP shows no thermal displacement. In addition, the process yields the highest energy efficiency (see point B in Fig. 11).

In summary, the need for process and tool cooling depends on the chosen process parameters. The highest energy efficiency for part finishing can be achieved with dry machining (point A), for semi-finishing with indirect cooled tools (point B), and for very high material removal rates with flood cooling (point C).

## 4 Conclusion

To conclude, this chapter shows the ongoing research in pursuit of a sustainable impact on the worldwide production industry by means of the development of innovative solutions for manufacturing environments. A special focus is placed on concepts for reconfigurable machine tools: where fluctuating production environments cannot be tackled by conventional static constructions, a modular building block system is designed that enables the production of homogenous products at high quality standards, lowest costs and featuring the option for partial replacement, repair, exchange, or upgrade with regular service intervals, therein avoiding

downtime or underutilization. The BBS concept encompassed various perspectives for overcoming technological limitations. The technological basis of the proposed LEG<sup>2</sup>O BBS consists of a scalable structure, where connections, interfaces and microsystem technology constitute elements for connecting and enabling the application of two basic module geometries of a hexagonal prism shape, involving active modules that allow for the compensation of thermal deformations. In this process, the actuator of different actuation principles as well as optimal placement within the machine tool frame serve together to improve energy efficiency and combines the advantages of the principles. In addition, passive modules provide stiffness and serve as the structural base.

Smart modules are enhanced by microsystem technology, namely wireless sensor nodes. Battery and energy harvesting technology in combination with highly efficient programming routines and customised hardware architecture allow for autonomous and flexible hard- and software infrastructure to synchronise all relevant data for the analysis of thermal distortion. Adaptive components then increase the accuracy of machine tools while remaining up-to-date.

The increase of the accuracy of machine tool frames, the usage of mechatronics regarding the accuracy of axes, as well as the “sustainable engineering” of solutions and recycling of components and equipment constitute the main parts of the research work at hand. Detail questions for the future concern communication reliability, data losses, environmental trade-offs between benefits and impact, as well as evaluation approaches for 25+ years of use time. A link between the microsystems’ impact on component level and modularity is so far still missing. Moreover, long-term compatibility between the different lifecycles and concepts of machine tool components and electronics needs to be investigated. Though modularisation was achieved on the hardware side of machine tools among various components, the net effect on sustainability of the modularisation of the machine tool frame remains an open question.

By upgrading outdated machine tools with add-on components, the accuracy of modern machine tools is achieved. Sensors of the add-on system can measure a significant portion of static, dynamic, and kinematic inaccuracies. These measurements are applied together with a feedback control to correct the errors through the use of piezoelectric actuators.

By upgrading or enhancing the functionality of older machine tools, valuable resources and energy consumption can be saved. This aim is realised without exchanging essential system components, but by using high precision compensation add-on systems. Sensors of the add-on system are able to measure a portion of static, dynamic and kinematic inaccuracies. The add-on compensation is realised by a separate control unit, making the development solution modularised and easily incorporated into different types of machine tools.

## References

- Abele, E., and A. Wörn. 2009. Reconfigurable machine tools and equipment. In *Changeable and reconfigurable manufacturing systems*, 111–125. Springer.
- Abele, E., H. Hanselka, F. Haase, D. Schlote, and A. Schiffler. 2008. Development and design of an active work piece holder driven by piezo actuators. *Production Engineering* 2(4): 437–442. doi:[10.1007/s11740-008-0123-3](https://doi.org/10.1007/s11740-008-0123-3).
- Aggogeri, F., F. Al-Bender, B. Brunner, M. Elsaid, M. Mazzola, A. Merlo, D. Ricciardi, M. de la O Rodriguez, and E. Salvi. 2013. Design of piezo-based AVC system for machine tool applications. *Mechanical Systems and Signal Processing* 36(1): 53–65. doi:[10.1016/j.ymssp.2011.06.012](https://doi.org/10.1016/j.ymssp.2011.06.012).
- Allwood, J.M., M.F. Ashby, T.G. Gutowski, and E. Worrell. 2011. Material efficiency: A white paper. *Resources, Conservation and Recycling* 55(3): 362–381. doi:[10.1016/j.resconrec.2010.11.002](https://doi.org/10.1016/j.resconrec.2010.11.002).
- Ast, A., S. Braun, P. Eberhard, and U. Heisel. 2007. Adaptronic vibration damping for machine tools. *CIRP Annals—Manufacturing Technology* 56(1): 379–382. doi:[10.1016/j.cirp.2007.05.088](https://doi.org/10.1016/j.cirp.2007.05.088).
- Beeby, S. 2006. Energy harvesting vibration sources for wireless sensor networks with special focus on vibrations.
- Brankamp, K., and J. Herrmann. 1969. Baukastensystematik—Grundlagen und Anwendung in Technik und Organisation. *Ind.-Anz* 91: 693–697.
- Brecher, C., and D. Manoharan. 2009. Aktive Dämpfung für Portalmaschinen: Entwicklung adaptronischer Kompensationsmodule für Schieberstrukturen. *wtWerkstattstechnik online* 99 (5): 288–293.
- Brecher, C., S. Bäumler, and B. Brockmann. 2013. Avoiding chatter by means of active damping system for machine tools. *Journal of Machine Engineering* 13(3): 117–128.
- Byrne, G., D. Dornfeld, and B. Denkena. 2003. Advanced cutting technology. *Annals of the CIRP—Manufacturing Technology* 52(2): 483–507.
- Chen, F., X. Lu, and Y. Altintas. 2014. A novel magnetic actuator design for active damping of machining tools. *International Journal of Machine Tools and Manufacture* 85: 58–69. doi:[10.1016/j.ijmachtools.2014.05.004](https://doi.org/10.1016/j.ijmachtools.2014.05.004).
- Denkena, B., et al. 2006. Life-cycle oriented development of machine tools. In *13th cooperative institutional research program international conference on life cycle engineering*, 693–698.
- Denkena, B., L. Overmeyer, K.M. Litwinski, and R. Peters. 2014. Compensation of geometrical deviations via model based-observers. *The International Journal of Advanced Manufacturing Technology* 73(5–8): 989–998. doi:[10.1007/s00170-014-5885-5](https://doi.org/10.1007/s00170-014-5885-5).
- Dornfeld, D.A. 2012. *Green manufacturing: fundamentals and applications*. Springer Science & Business Media.
- Drossel, W.-G., A. Bucht, C. Hochmuth, A. Schubert, A. Stoll, J. Schneider, and R. Schneider. 2014. High performance of machining processes by applying adaptronic systems. *Procedia CIRP* 14: 500–505.
- Elfizy, A.T., G.M. Bone, and M.A. Elbestawi. 2005. Design and control of a dual-stage feed drive. *International Journal of Machine Tools and Manufacture* 45(2): 153–165. doi:[10.1016/j.ijmachtools.2004.07.008](https://doi.org/10.1016/j.ijmachtools.2004.07.008).
- Elvin, Niell, Erturk, Alper (Eds.). 2013. Advances in energy harvesting methods. doi:[10.1007/978-1-4614-5705-3](https://doi.org/10.1007/978-1-4614-5705-3).
- Eriksson, B. 2007. Control strategy for energy efficient fluid power actuators. Lic Thesis, LiU-Tryck, Linköping.

- Gontarz, A., F. Hänni, L. Weiss, and K. Wegener. 2012. Machine tool optimization strategies: Evaluation of actual machine tool usage and modes. In *Sustainable manufacturing*, ed. Günther Seliger, 131–36. Berlin: Springer.
- Gungor, V.C., and G.P. Hancke. 2009. Industrial wireless sensor networks: Challenges, design principles, and technical approaches. *IEEE Transactions on Industrial Electronics* 56(10): 4258–4265.
- Harris, P., S. Nolan, and G.E. O'Donnell. 2014. Energy optimisation of pneumatic actuator systems in manufacturing. *Journal of Cleaner Production* 72: 35–45.
- Heisel, U., and M. Lutz. 1993a. Probleme der umwelt- und humanverträglichen Fertigung am Beispiel der Kühlschmierstoffe – Erster Teil, DIMA, 93/8.9:81–83.
- Heisel, U., and M. Lutz. 1993b. Probleme der umwelt- und humanverträglichen Fertigung am Beispiel der Kühlschmierstoffe – Zweiter Teil. *DIMA* 93(10): 35–40.
- Hömberg, D., E. Uhlmann, O. Rott, and P. Rasper. 2013. Development of a stability prediction tool for the identification of stable milling processes. In *Process machine interactions*, ed. B. Denkena, and F. Hollmann, 203–224. Springer.
- Hu, P. 2015. A system architecture for software-defined industrial Internet of Things. In *IEEE international conference on ubiquitous wireless broadband (ICUWB)*. Paris: IEA Publications.
- International Energy Agency. 2007. *Tracking industrial energy efficiency and CO<sub>2</sub> emissions*. Paris: IEA Publications.
- Ito, Y. 2008. *Modular design for machine tools*. McGraw Hill Professional.
- Kianinejad, K., E. Uhlmann, and B. Peukert. 2015. Investigation into energy efficiency of outdated cutting machine tools and identification of improvement potentials to promote sustainability. *Procedia CIRP* 26: 533–538.
- Kianinejad, K., S. Thom, S. Kushwaha, and E. Uhlmann. 2016. Add-on error compensation unit as sustainable solution for outdated milling machines. *Procedia CIRP* 40: 174–178.
- Klocke, F., and G. Eisenblatter. 1997. Dry cutting. *Annals of the CIRP-Manufacturing Technology* 46(2): 519–526.
- Koren, Y., et al. 1999. Reconfigurable manufacturing systems. *CIRP Annals-Manufacturing Technology* 48(2): 527–540.
- Lambebo, A., and S. Haghani. 2014. A wireless sensor network for environmental monitoring of greenhouse Gases. In *ASEE 2014 zone I conference*.
- Law, M., et al. 2015. Active vibration isolation of machine tools using an electro-hydraulic actuator. *CIRP Journal of Manufacturing Science and Technology* 10: 36–48.
- Liu, D., and F. Fuji. 2014. An adaptive internal model control system of a piezo-ceramic actuator with two RBF neural networks. In *2014 IEEE international conference on mechatronics and automation (ICMA)*, 210–215. doi:[10.1109/ICMA.2014.6885697](https://doi.org/10.1109/ICMA.2014.6885697).
- Mori, M., and M. Fujishima. 2009. Reconfigurable machine tools for a flexible manufacturing system. In *Changeable and reconfigurable manufacturing systems*, 101–109. Springer.
- Narendra, K.S., and K. Parthasarathy. 1990. Identification and control of dynamical systems using neural networks. *IEEE Transactions on Neural Networks/A Publication of the IEEE Neural Networks Council* 1(1): 4–27. doi:[10.1109/72.80202](https://doi.org/10.1109/72.80202).
- Okwudire, C., and J. Lee. 2013. Minimization of the residual vibrations of ultra-precision manufacturing machines via optimal placement of vibration isolators. *Precision Engineering* 37(2): 425–432.
- Okwudire, C., and J. Rodgers. 2013. Design and control of a novel hybrid feed drive for high performance and energy efficient machining. *CIRP Annals-Manufacturing Technology* 62(1): 391–394.
- Ovsthus, K., and Lars M. Kristensen. 2014. An industrial perspective on wireless sensor networks —a survey of requirements, protocols, and challenges. *IEEE Communications Surveys & Tutorials* 16(3): 1391–1412.



- Peukert, B., J. Mewis, M. Saoji, E. Uhlmann, S. Benecke, R. Thomasius, N. F. Nissen, and K.-D. Lang. 2013. Microsystem enhanced machine tool structures to support sustainable production in value creation networks.
- Peukert, B., M. Saoji, and E. Uhlmann. 2015a. An evaluation of building sets designed for modular machine tool structures to support sustainable manufacturing. *Procedia CIRP* 26: 612–617.
- Peukert, B., S. Benecke, J. Clavell, S. Neugebauer, N. F. Nissen, E. Uhlmann, K.-D. Lang, and M. Finkbeiner. 2015b. Addressing sustainability and flexibility in manufacturing via smart modular machine tool frames to support sustainable value creation. *Procedia CIRP* 29: 514–519.
- Rault, T., A. Bouabdallah, and Y. Challal. 2014. Energy efficiency in wireless sensor networks: A top-down survey. *Computer Networks* 67: 104–122.
- Schischke, K. 2009. *Innovations- und Technikanalyse autonomer verteilter Mikrosysteme: Schlussbericht*. Berlin, Hannover: Technische Informationsbibliothek u. Universitätsbibliothek.
- Sheltami, T., A. Al-Roubaiey, A. Mahmoud and E. Shakshuki. 2015. A publish/subscribe middleware cost in wireless sensor networks: A review and case study. In *IEEE 28th Canadian conference on electrical and computer engineering (CCECE)*.
- Steinberg, U., and H.-J. Windberg. 2011. *Heben und Tragen ohne Schaden*. Dortmund: Baua.
- Tiwari, A., R. Jaideva, and S. K. Pradhan. 2015. An investigation into use of different soft artificial intelligence techniques in mechanical engineering domain. In *Proceedings of fourth international conference on soft computing for problem solving*, ed. K.N. Das, K. Deep, M. Pant, J.C. Bansal and A. Nagar, 521–541. Springer.
- Uhlmann, E., and K. Kianinejad. 2013. Investigation of the upgrading potentials of out-of-date cutting machine tools to promote sustainable and global value creation. In *Proceeding of the 11th global conference on sustainable manufacturing*, ed. G. Seliger, 574–579. Berlin: University Publisher of TU Berlin.
- Uhlmann, E., and B. Peukert. 2015. Erhöhen der Dämpfung hohler Leichtbaustrukturen: Ein passiver und nachhaltiger Ansatz zur Verbesserung der Strukturdämpfung. *Wt Werkstattstechnik online* 105(7/8): 446–450.
- Uhlmann, E., P. Fürstmann, M. Roeder, S. Richarz, and F. Sammler. 2012. Tool wear behaviour of internally cooled tools at different cooling liquid temperatures. In *Proceedings of the 10th global conference on sustainable manufacturing*, ed. G. Seliger, and E. Kılıç, 21–27. Berlin: University Publisher of TU Berlin.
- Uhlmann, E., M. Saoji, S. Kushwaha, and B. Peukert. 2014. Optimierte Sensorplatzierung in Mess-Netzwerken. *Werkstattstechnik online* 5: 266–271.
- Uhlmann, E., M. Saoji, and B. Peukert. 2016. Utilization of thermal energy to compensate quasi-static deformations in modular machine tool frames. *Procedia CIRP* 40: 1–6.
- Verein Deutscher Werkzeugmaschinenfabriken e.V. 2015. Marktbericht 2014: Die deutsche Werkzeugmaschinenindustrie und ihre Stellung im Weltmarkt [Online]. <http://www.vdw.de/>. Accessed 11 April 2016.
- Wagner, E., S. Benecke, J. Winzer, N.F. Nissen, and K.-D. Lang. 2016. Evaluation of indicators supporting the sustainable design of electronic systems. *Procedia CIRP* 40: 469–474.
- Ward, H., M. Burger, Y. Chang, P. Fürstmann, S. Neugebauer, A. Radebach, G. Sproesser, A. Pittner, M. Rethmeier, E. Uhlmann, J. Steckel. 2016. Assessing carbon dioxide emission reduction potentials of improved manufacturing processes using multiregional input output frameworks. *Journal of Cleaner Production*. doi:10.1016/j.jclepro.2016.02.062.



- Woronko, A., J. Huang, and Y. Altintas. 2003. Piezoelectric tool actuator for precision machining on conventional CNC turning centers. *Precision Engineering* 27(4): 335–345. doi:[10.1016/S0141-6359\(03\)00040-0](https://doi.org/10.1016/S0141-6359(03)00040-0).
- Wulfsberg, J. P., A. Verl, K.-H. Wurst, S. Grimske, C. Batke, and T. Heinze. 2013. Modularity in small machine tools. *Production Engineering* 7(5): 483–490.
- Zurawski, R. 2009. Wireless sensor network in industrial automation. In *International conference on embedded software and systems, Pittsburgh, 2009*.

**Open Access** This chapter is licensed under the terms of the Creative Commons Attribution 4.0 International License (<http://creativecommons.org/licenses/by/4.0/>), which permits use, sharing, adaptation, distribution and reproduction in any medium or format, as long as you give appropriate credit to the original author(s) and the source, provide a link to the Creative Commons license and indicate if changes were made.

The images or other third party material in this chapter are included in the book's Creative Commons license, unless indicated otherwise in a credit line to the material. If material is not included in the book's Creative Commons license and your intended use is not permitted by statutory regulation or exceeds the permitted use, you will need to obtain permission directly from the copyright holder.



# Sustainable Technologies for Thick Metal Plate Welding

**Gunther Sproesser, Ya-Ju Chang, Andreas Pittner,  
Matthias Finkbeiner and Michael Rethmeier**

**Abstract** Welding is the most important joining technology. In the steel construction industry, e.g. production of windmill sections, welding accounts for a main part of the manufacturing costs and resource consumption. Moreover, social issues attached to welding involve working in dangerous environments. This aspect has unfortunately been neglected so far, in light of a predominant focus on economics combined with a lack of suitable assessment methods. In this chapter, exemplary welding processes are presented that reduce the environmental and social impacts of thick metal plate welding. Social and environmental Life Cycle Assessments for a thick metal plate joint are conducted for the purpose of expressing and analysing the social and environmental impacts of welding. Furthermore, it is shown that state-of-the-art technologies like Gas Metal Arc Welding with modified spray arcs and Laser Arc-Hybrid Welding serve to increase social and environmental performance in contrast to common technologies, and therefore offer great potential for sustainable manufacturing.

**Keywords** Life Cycle Assessment (LCA) · Arc Welding · Laser Arc-Hybrid Welding · Resource efficiency · Social Life Cycle Assessment (SLCA) · Human health

---

G. Sproesser (✉) · M. Rethmeier  
Institute of Machine Tools and Factory Management, Technische Universität Berlin,  
Berlin, Germany  
e-mail: [gunther.sproesser@googlemail.com](mailto:gunther.sproesser@googlemail.com)

Y.-J. Chang · M. Finkbeiner  
Department of Environmental Technology, Technische Universität Berlin, Berlin,  
Germany

A. Pittner · M. Rethmeier  
Department of Component Safety, Federal Institute for Materials Research and Testing,  
Berlin, Germany

© The Author(s) 2017  
R. Stark et al. (eds.), *Sustainable Manufacturing*, Sustainable Production,  
Life Cycle Engineering and Management, DOI 10.1007/978-3-319-48514-0\_5

## 1 Introduction

Welding plays a pivotal and irreplaceable role in modern manufacturing. The applications are involved in nearly all industries, for example, construction, automobile, turbine production, etc. Yet welding processes require large amounts of energy and resources which are of course critical from an environmental perspective. Social aspects of welding meanwhile mainly involve health effects associated with welding fumes and welder compensation.

Common welding technologies include Gas Metal Arc Welding (GMAW), Manual Metal Arc Welding (MMAW) and Laser Arc-Hybrid Welding (LAHW), which all differ tremendously in their properties and potential in the realm of sustainable manufacturing.

MMAW with coated electrodes is a popular welding technology on building sites due to the fact that it offers high flexibility and requires no shielding gas supply. Additionally, low costs of equipment and electrodes incentivize the frequent application of MMAW. On the other hand, the productivity attached to MMAW tends to be low due to limited welding speeds, process power capacity limitations, as well as the attendant additional time consumption at play when changing the electrode and removing the slag. Furthermore, MMAW is performed manually, which entails significant health risks for welders.

Meanwhile GMAW is one of the most widely used technologies due to the fact that it is easy to automate and offers a high level of productivity and flexibility. The typical operation mode of GMAW for the purpose of achieving high deposition rates and process speeds, is automatic welding with spray arc transfer. Recently, manufacturers of welding power sources have developed modern arc processes as presented early by Dzelnitzki (2000), and later by Lezzi and Costa (2013). One innovation is a highly concentrated spray arc that enables higher penetration depths and the reduction of flange angles. Consequently, the modern modified spray arcs lead to reduced material consumption which prove to be promising with respect to environmental aspects.

Then there's LAHW, which remains a rather young technology compared to those mentioned above, yet is well on its way as a promising new field of sustainable manufacturing. In comparison with GMAW, LAHW achieves higher welding speeds and hence higher productivity, while the reduced number of passes and lower volume of molten material lead to resource savings, lower distortion and less rework. Yet when it comes to large structures with high geometrical tolerances of several millimetres, gap bridging can be a critical issue ultimately limiting the application of LAHW as it stands.

For manufacturing processes and products, environmental and social issues are often insufficiently considered and respected. The negative effects on the environment and humans however accumulate, many of which are also irreversible. To evaluate the environmental impacts and social influences of a process or product, Life Cycle Assessment (LCA) (ISO 2006a; Schau et al. 2012), and Social Life Cycle Assessment (SLCA) (UNEP 2009) are the current state-of-the-art

methodologies. LCA is an ISO standardised method, widely employed for providing an estimate on the potential environmental impacts of products through the whole life cycle (Schau et al. 2012; Klöpffer and Grahl 2009; Guinée et al. 2002). It is the most advanced and tried-and-true methodology in evaluating environmental burden on process or product levels, and also in preventing burden shifting from different life cycle phases.

According to the guidelines for Social Life Cycle Assessment of Products (UNEP 2009), SLCA is defined as a methodology that aims at assessing the potential positive and negative social and socio-economic impacts related to human beings affected by products/services throughout the life cycle, such as health and wage issues of workers, etc. Though SLCA studies have increased in number significantly within the last three years, the method is still considered to be rather in its infancy (Neugebauer et al. 2015).

To date, welding technology developments and comparisons remain predominantly focused on economic indicators. Environmental and social aspects are insufficiently taken into account when evaluating and choosing a process for a given welding task. To that end, MMAW, LAHW and automatic GMAW with a conventional spray arc and a modified spray arc, have been evaluated in view of the environmental and social aspects attached. SLCA and LCA have been applied to compare the corresponding environmental impacts and the potential health risks to welders, particularly caused by welding fumes. Moreover, the wage status of welders in Germany has been investigated with a discussion of the fairness and adequacy given their working and living conditions. The results can help the industry to identify the crucial issues and then offer improvements to the processes and equipment in pursuit of more sustainable alternatives.

## 2 Methodology

### 2.1 *Environmental Assessment*

According to the ISO standard, the methodology is divided into these four phases: goal and scope definition, life cycle inventory analysis, life cycle impact assessment, and interpretation in an iterative process (ISO 2006a, b). First of all, the goals of this LCA study are to highlight the environmental impact contributed by different inputs and outputs of the chosen welding processes, and to compare the differences in environmental impact. The results are expected to provide information for welding process development and selection. The scope of the study is concerned with the welding processes in and of themselves, including the life cycle stages of material acquisition (involving in raw material extraction and processing of the used material in welding processes), the manufacturing phase (carrying out welding processes), and waste management. In line with the defined scope, the system boundary covers the consumption of electricity, materials and gases, and landfill

### System boundary

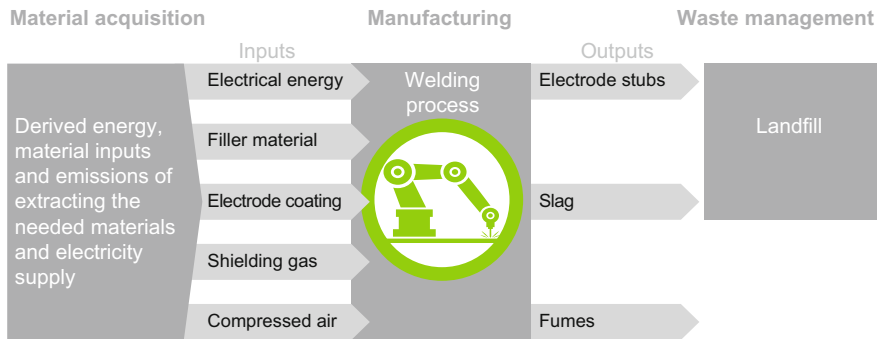

**Fig. 1** System boundary and inputs and outputs of welding processes (Sproesser et al. 2015)

waste, but stops short of considering machinery. The functional unit is 1 m weld seam of a 20 mm thick metal plate. The input and output information based on the defined functional unit will be collected and calculated in life cycle inventory analysis stage. In this study, the CML 2002 method is adopted as the life cycle impact assessment method (as the midpoint approach). Meanwhile, GaBi 6.0 (by thinkstep) is used as the software to build and carry out the LCA model.

In the life cycle inventory analysis phase, the inventory data of inputs and outputs of the chosen welding processes are collected according to the system boundary and the functional unit. Figure 1 shows the considered process inputs and outputs, filler material, shielding gas, electrical energy, welding fumes, compressed air (for LAHW), electrode coating (for MMAW), electrode stubs (for MMAW), and slag (for MMAW).

Electricity consumption for the welding processes was determined with values measured and the respective wall-plug efficiency of the equipment. The wall-plug efficiency of arc welding machines (MMAW, GMAW and the arc content of LAHW) was set to 80 % (Sproesser et al. 2016; Hälsig 2014). For LAHW, electricity consumption of the beam source took into account process power, an efficiency of 30 %, and additional contributions of the cooling unit. Electric energy for robot movement was measured at the feed cable for the respective trajectories and added to the electricity demand of the welding source in order to calculate the overall energy utilised for the joining process.

The consumption of filler material was determined by measurement of the wire feed rate and in the case of MMAW, by weighting the electrodes and by collecting the remaining electrode stubs. The chemical compositions of the materials were taken from available product data sheets. For MMAW, only titanium dioxide (45 %) and silicon dioxide (10 %) were considered to represent the main composition of the electrode coating due to missing data in the GaBi data base. The consumption of compressed air for LAHW was estimated by applying Bernoulli's principle to the geometry of the cross-jet unit of the laser head.

**Table 1** Fume emission rates of the applied welding processes

	Emission rate
MMAW	4 mg/min (Pohlmann et al. 2013)
GMAW standard	6 mg/s (Rose et al. 2012)
GMAW modified	4 mg/s (Rose et al. 2012)
LAHW	LAHW root pass: 10.4 mg/s (Pohlmann et al. 2013) GMAW filler pass: 6 mg/s (Rose et al. 2012)

Fume emissions are calculated according to emission rates of representative processes (power range and transfer mode) from literature (Pohlmann et al. 2013; Rose et al. 2012) and are displayed in Table 1. The chemical composition is assumed to be mainly from iron oxide (Antonini et al. 2006; Jenkins and Eagar 2005).

Considering the robustness, practicality, and the close relationship between welding technologies and metal related industry, the four indicators: global warming potential (GWP), eutrophication potential (EP), acidification potential (AP) and photochemical ozone creation potential (POCP) have been selected for further comparison in life cycle impact assessment stage (World Steel Association 2011; PE International 2014). GWP (100 years, in kg of carbon dioxide equivalent) evaluates the long-term contribution of a substance to climate change. EP (in kg phosphate equivalent) estimates the impact from the macro-nutrients nitrogen and phosphorus in bio-available forms on aquatic and terrestrial ecosystems, affecting undesired biomass production. AP (in sulfur dioxide equivalent) addresses the impacts from acidification generated by the emission of airborne acidifying chemicals. Acidification refers literally to processes that increase the acidity of water and soil systems by hydrogen ion concentration (Institute for Environment and Sustainability of Joint Research Centre of European Commission 2010). Then there's POCP (in kg ethene equivalent), which rates the creation of ozone (due to reaction of a substance in presence of NO<sub>x</sub> gases), also known as summer smog (Guinée et al. 2002). The negative impact causes respiratory diseases and oxidative damage on photosynthetic organelles in plants (Institute for Environment and Sustainability of Joint Research Centre of European Commission 2010). In the final phase, the results from life cycle impact assessments are interpreted.

## 2.2 Social Assessment

In the SLCA guidelines, the methodology framework is proposed similar to LCA: goal and scope definition, life cycle inventory analysis, life cycle impact assessment and interpretation (Chang et al. 2012; UNEP 2009). In the guidelines, five main stakeholder groups (workers, consumers, local community, society and value chain actors) and 31 subcategories are described and the relevant social issues are then listed. Due to the high level of importance held by the stakeholders responsible for

welders' welfare in Germany, the two critical social conditions "fair salary" and "health and safety" have been selected for the social assessment.

The sufficiency status of salary for welders in Germany can be recognized by comparing the average wage of welders (FOCUS Online 2012), the national minimum wage (Statistisches Bundesamt 2016a) and at-risk-of-poverty threshold (Statistisches Bundesamt 2016b). The at-risk-of-poverty threshold serves as a yardstick for identifying whether people live in income-dependent poverty. In this chapter, gross monthly wage and poverty threshold for a single person are used for comparison. The reference year for the national minimum wage and at-risk-of-poverty threshold is 2015, but the average wage of welders is taken from 2011 due to the statistical data limitation.

In addition to fair salary, the relative health and safety effects on welders performing different welding technologies have been analysed, with a specific look at exposure to welding fumes. Welding processes generate a complex mixture of fumes (respirable and ultrafine particles) as by-products composed of an array of metals volatilised from the welding electrode or the flux materials incorporated (Antonini et al. 2006). Welders' exposure to welding fumes is often associated with acute and chronic lung damage, lung cancer and other potential harm on heart, kidneys and central nervous systems (Gonser and Hogan 2011; Canadian Centre for Occupational Health & Safety 2016). Iron oxides constitute the main part of the fume, while chromium, manganese, and nickel account for the total remaining fume composition (Antonini et al. 2006; Jenkins and Eagar 2005). Iron oxide is not officially classified as a human carcinogen. Nevertheless, it has proven to trigger siderosis, which decreases lung capacity. Chromium (VI, insoluble) and its compounds are known as a human lung carcinogen, while nickel is also known as a human carcinogen, causing lung, nasal, and sinus cancers. Manganese and its compounds are not carcinogens, but associated with central nervous system (CNS) effects similar in nature to Parkinsonism (Gonser and Hogan 2011). To represent the relative potential risk caused by fumes on the health of welders, we have identified the hazard figure (Gefährdungszahl,  $GZ$ ) of the welding processes. Based on the literature (Spiegel-Ciobanu 2012), the model simplifies and considers process-specific fume emissions associated with the working situation. For estimating the simplified potential risk  $GZ_s$ , the following Eq. 1 is used (Spiegel-Ciobanu 2012):

$$GZ_s = (E_p \times W_p) \times L \times R \times K_b \quad (1)$$

$E_p$  = emission factor of the specific substance per functional unit;

$W_p$  = potential effect for the specific substances in fume;

$L$  = ventilation factor (have sufficient ventilation or not);

$R$  = spatial factor (outside or in rooms);

$K_b$  = the factor of relative distance of head/body and fume source.

$E_p$  represents the fume emissions per functional unit of 1 m weld seam and is calculated based on the inventory data for fume emissions of the LCA (see Sect. 2.1). It is a relative factor taking the minimal emissions per functional unit as

a reference value. Since the distance between welders and fume sources in different welding processes vary widely, the  $K_b$  levels are set correspondingly. The closer distance indicates a higher chance of inhaling fume. MMAW is executed manually and welders are close to the fume sources, so the levels are set as 4 (Spiegel-Ciobanu 2012); in GMAW (executed with a robot), the  $K_b$  level is assumed as 2 due to there usually being some distance between welders and fume sources; in LAHW, the welding process is performed in welding cells, so the  $K_b$  level is defined as 1 (Spiegel-Ciobanu 2012). Targeting the comparison of potential risks,  $W_p$  can be assumed as the same value as 1 to represent no difference in comparison between the processes since the composition of materials in the chosen welding processes are highly similar. Also, the  $L$  and  $R$  both are set as 1 in the paper due to the condition of welding places assumed to be identical. Following Eq. 1 and the assumptions, the potential health risk,  $GZ_s$ , is highly influenced by the emission factor per functional unit  $E_p$  and the relative distance of head/body and fume source  $K_b$ . The  $GZ_s$  can be simply represented as  $E_p \times K_b$ .

### 2.3 Welding Experiments

Welding was carried out in four types of technologies: MMAW, LAHW, and GMAW in modified spray arc (GMAW modified) and the conventional spray arc (GMAW standard). Low alloyed structural steels and proper filler wires were used as a base and filler metal. Weld samples were plates of 20 mm thickness with weld seam lengths from 250 to 300 mm. Welding was performed in the flat position

**Table 2** Material, joint specifications and process parameters of MMAW and LAHW

	MMAW	LAHW
Joint preparation	Double-V (ISO 9692-1) 60° groove angle 2 mm root gap 2 mm root face	Y-groove (ISO 9692-1) 45° groove angle No root gap 14 mm root face
Base material	S355 + N (DIN EN 10025-3)	X120 (API 5L)
Filler material	E 42 0 RR 1 2 (DIN EN ISO 2560-A)	Mn4Ni2CrMo (DIN EN ISO 16834)
Shielding gas	–	82 % Argon, 18 % CO <sub>2</sub>
<i>Process parameters</i>		
Average welding speed in mm/s	2.8	LAHW: 43.3 GMAW filler pass: 13.3
Number of passes	8	2
Average power in kW	4	Root pass: 33 (Laser + GMAW) Filler pass: 11 (GMAW only)



**Table 3** Material, joint specifications and process parameters of GMAW standard and GMAW modified

	GMAW standard	GMAW modified
Joint preparation	Double-V (ISO 9692-1), 60° groove angle 0.4 mm root gap 2 mm root face	Double-V (ISO 9692-1) 30° groove angle 0.2 mm root gap 2 mm root face
Base material	S690 QL (DIN EN 10025-6)	S960 QL (DIN EN 10025-6)
Filler material	Mn3Ni1CrMo (DIN EN ISO 16834)	Mn4Ni2CrMo (DIN EN ISO 16834)
Shielding gas	82 % Argon, 18 % CO <sub>2</sub>	
<i>Process parameters</i>		
Average welding speed in mm/s	6.2	6.7
Number of passes	4	2
Average power in kW	8	12

(1 G) and data was calculated with regards to the functional unit of 1 m weld seam. Material specifications, groove preparations and process parameters of the processes are listed in Tables 2 and 3.

### 3 Case Study Results and Discussion

#### 3.1 Environmental Assessment

The LCA study highlights the environmental impacts contributed by different inputs and outputs of the chosen welding processes and compares the differences of environmental impacts. The life cycle inventory data is shown in Table 4 based on the functional unit. The inventory is used to conduct life cycle impact assessments.

By carrying out impact assessment within CML method and GaBi 6.0 software, the environmental impacts GWP, EP, AP and POCP contributed by the selected welding processes have been estimated, as shown in Fig. 2. The results indicate that MMAW causes the highest environmental impact in the chosen impact categories among the selected processes, and the LAHW variant provides the lowest. In addition, the modified spray arc with the smaller groove angle contributes significantly lower impact than the standard GMAW variant. For GMAW and LAHW, electric energy and filler material are the dominant influencing factors. For MMAW, the electrode coating is of major relevance, along with filler material and electric energy.

**Table 4** Life cycle inventory of the welding processes

	MMAW	GMAW standard	GMAW modified	LAHW
Filler material in g	944	890	530	155
Shielding gas in l	–	241	100	33
Electrode coating in g	580	–	–	–
Compressed air for laser optics cross-jet in l	–	–	–	249
Electric energy in kWh	3.9	2.1	1.3	0.9
Welding fumes in g	11.6	3.6	1.2	0.6
Slag in g	600	–	–	–
Electrode stubs in g	150	–	–	–

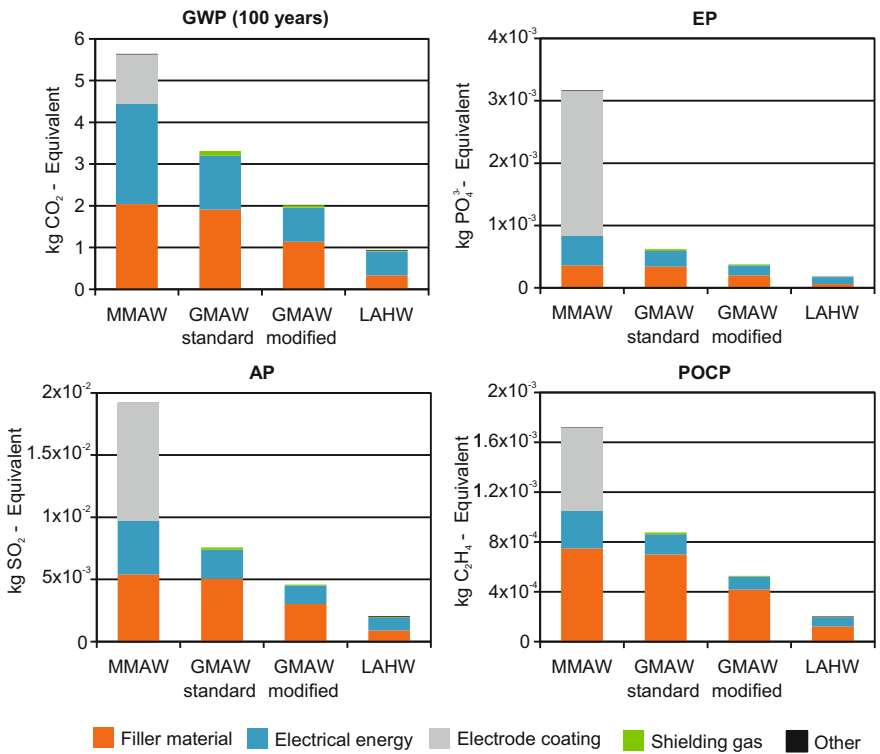

**Fig. 2** Results of the impact assessment

Among the processes investigated in joining a 20 mm thick plate of structural steels, LAHW is the best option hands down when considering the environmental impact caused. Due to its high power density, LAHW performs welding with both the least number of passes and overall weld volume. Additionally, LAHW allows for high welding speed, leading to high productivity and low electricity and gas

consumptions. This is a remarkable finding considering the low beam source efficiency of 30 % in contrast to 80 % efficiency of arc welding machines. The main reason for less environmental impact in LAHW lies in the better ratio between power consumed and welding time, which means that the low efficiency is over-compensated by welding time savings. Either filler material or electric energy is dominant depending on the indicator considered. Both can be optimized by means of enlargement of the root face width and a smaller opening angle. Moreover, electric energy consumption could be further reduced significantly by increasing the beam source efficiency.

Contrary to LAHW, low process performance (deposition rate and welding speed) and the necessary edge preparation in MMAW lead to the highest environmental effects. Low deposition rate and welding speed result in higher amounts of energy that are used to re-melt weld metal in the subsequent passes, as well as energy losses due to heat conduction into the base material. Furthermore, electrode coating accounts for a remarkable share of environmental impact even though only 55 % of the electrode composition is considered in the LCA model. It is likely that results would be even worse for MMAW if electrode coating could be fully accounted for. In order to mitigate environmental impact, the industry should therefore focus firstly on rutile electrode coatings and then on joint design. Smaller root gaps and opening angles would reduce electric energy and material (filler as well as coatings) consumption. Thickness of electrode coatings can be reduced and alternative compositions can be further investigated (e.g. basic or acid coated electrodes) with respect to their environmental impact.

Filler material consumption dominates about 54–80 % of the instances of impact in GMAW in the chosen categories. The benefit of reducing opening angles can be directly stated by comparing GMAW with the standard spray arc and the modified spray arc. This leads to approximately 40 % reduction of the environmental impact level. Hence, in order to improve GMAW from an environmental perspective, joints should always be designed with the minimum possible flange angle. However, it is unclear whether optimisation options are technologically feasible or whether they guarantee the optimal weld performance, all of which should be evaluated properly.

Welding robot movements for all technologies account for a small share of electricity consumption. As a result, the energy efficiency attached to joining industrial parts is dominated by the welding process itself and has to be adequately assessed in future work accordingly.

The LCA results show clear environmental preferences. Nevertheless, gaps and limitations of the study must be acknowledged, for example the challenges embedded in LCA methodology (Finkbeiner et al. 2014) and the possible variation of results due to different process requirements in welding technology. Process requirements such as efforts for edge preparation, effects of different welding positions or mobility of equipment could furthermore have a crucial influence on process selection. In the LCA model, only four impact categories are considered for comparison, which can lead to inconclusive judgment. What's more, machinery is not considered, which could cause potential bias and require a critical overall weld seam length before proving to be environmentally beneficial.

### 3.2 Social Assessment

The latest salary survey from Focus Online (FOCUS Online 2012) showed the average gross salary per month of welders in Germany in 2011 to be €2,165; the national minimum wage was €1,430 (Statistisches Bundesamt 2016a); and the poverty threshold for a single person was deduced to be €986.67 based on the national statistics (Statistisches Bundesamt 2016b). The results indicate that the average monthly wage of welders is higher than the current national minimum wage and the deduced poverty threshold (approximate 2 times). It is therefore fair to conclude that welders' salary status is sufficient for supporting their overall subsistence and for meeting the income regulation of minimum wage.

The evaluation of the potential risks  $GZ_s$  of the applied welding processes are displayed in Table 5. The emission factors  $E_p$  are calculated based on the inventory data shown in Table 4, taking the emission of LAHW as the reference value for estimating the ratios. Thus, LAHW constitutes the lowest potential health risk. This is because it is conducted in closed cells due to laser safety restrictions. MMAW owns the highest  $GZ_s$  to welders among all the selected processes. GMAW standard and GMAW modified have smaller differences of the  $GZ_s$  since they only differ in the quantity of fume formation. The results underline that welders working in the manual processes (like MMAW) face higher risks than in automatic processes (GMAW, LAHW). Consequently, it is important to limit the application of manual welding processes to the minimum possible extent. Moreover, the personal protective equipment used should be adequate to minimize the health risks for welders. In case of automatic GMAW, the future goal should be to keep welders out of the process zone. However, this requires technologies for advanced process control and monitoring to ensure the quality of the welds. Apart from the potential health risks posed by welding fumes, further factors in welding contribute to the category "health and safety." In particular, electrical, thermal and radiation hazards or the workplace ergonomics should be evaluated in the future in the pursuit of an improved working environment for welders.

In summary, the SLCA showed a sufficient wage level from which welders may support themselves financially. Potential health risks of operation depend on the respective process and are high for manual processes such as MMAW.

**Table 5** The estimation of relative health effects of the welding processes

	$E_p$	$K_b$	$GZ_s$
MMAW	19	4	76
GMAW standard	6	2	12
GMAW modified	2	2	4
LAHW	1	1	1

## 4 Conclusions

This contribution evaluates the environmental impact and social influences of welding technologies by applying LCA and SLCA. It provides information to the industry as well as to the research community for developing and selecting joining technologies in view of the triple bottom line of sustainability.

The instances of environmental impact involved the selected impact categories of eutrophication potential, acidification potential, global warming potential (100 years) and photochemical ozone creation potential. The social categories were “fair salary” and “health and safety.” The results serve to support industry in the development and selection of sustainable joining technologies.

The LCA results show that MMAW contributes higher environmental impact levels than GMAW or LAHW. The main cause is that MMAW consumes much more material and electricity per 1 m weld seam. Titanium dioxide consumption for electrode coating in MMAW is critical in contributing the main burden of acidification and eutrophication. GMAW is strongly influenced by filler material consumption, which is governed by the seam preparation. This is improved by using a modified spray arc, which ultimately enables a reduction of flange angles from 60° to 30°. Within the scope of the study, LAHW stands as the superior technology.

The social LCA revealed a sufficient salary for welders and potential health risks that depend on the applied process. LAHW demonstrates the lowest and MMAW the highest potential health risks that arise from fume formation. Especially manual technologies such as MMAW should therefore be limited to the minimum possible extent to reduce health risks for welders.

## References

- Antonini, J.M., A.A. Afshari, S. Stone, B. Chen, D. Schwegler-Berry, W.G. Fletcher, W.T. Goldsmith, et al. 2006. Design, construction, and characterization of a novel robotic welding fume generator and inhalation exposure system for laboratory animals. *Journal of Occupational and Environmental Hygiene* 3(4): 194–203. doi:10.1080/15459620600584352.
- Canadian Centre for Occupational Health & Safety. 2016. Occupations & workplaces: welders. Canadian Centre for Occupational Health & Safety. [http://www.ccohs.ca/oshanswers/occup\\_workplace/welder.html](http://www.ccohs.ca/oshanswers/occup_workplace/welder.html). Accessed 25 July 2016.
- Chang, Y.-J., E. Schau, and M. Finkbeiner. 2012. Application of life cycle sustainability assessment to the bamboo and aluminum bicycle in surveying social risks of developing countries. Paper presented at the 2nd World Sustainability Forum, Web Conference, 1–30 November 2012.
- Dzelnitzki, D. 2000. Vergrößerung des Einbringvolumens oder Erhöhung der Schweißgeschwindigkeit? – Vorteile des MAG-Hochleistungsschweißens. <https://www.ewm-group.com/de/service/downloads/fachaufsaetze/migmag-schweissen/136-vergroesserung-des-einbringvolumens-oder-erhoehung-der-schweissgeschwindigkeit-vorteile-des-mag-hochleistungsschweissens.html>. Accessed 25 July 2016.
- Finkbeiner, M., R. Ackermann, V. Bach, M. Berger, G. Brankatschk, Y.-J. Chang, M. Grinberg, et al. 2014. Challenges in life cycle assessment: An overview of current gaps and research

- needs. In *Background and future prospects in life cycle assessment*, ed. Walter Klöpffer, 207–258. Dordrecht: Springer.
- FOCUS Online. 2012. 150 Berufe im Gehaltsüberblick. [http://www.focus.de/finanzen/karriere/tid-28806/titel-deutschlands-groesster-gehalts-report-150-berufe-im-gehaltsueberblick\\_aid\\_890328.html](http://www.focus.de/finanzen/karriere/tid-28806/titel-deutschlands-groesster-gehalts-report-150-berufe-im-gehaltsueberblick_aid_890328.html). Accessed 2 May 2014.
- Gonser, M. and T. Hogan. 2011. Arc welding health effects, fume formation mechanisms, and characterization methods. In *Arc welding*, ed. by Wladislav Sudnik. doi:10.5772/29131.
- Guinée, J.B., M. Gorrée, R. Heijungs, G. Huppes, R. Kleijn, A. de Koning, L. van Oers, et al. 2002. *Handbook on life cycle assessment—operational guide to the ISO standards*. New York: Kluwer Academic Publishers.
- Hälsig, A. 2014. Energetische Bilanzierung von Lichtbogenschweißverfahren. Ph.D. dissertation, Technische Universität Chemnitz.
- Institute for Environment and Sustainability of Joint Research Centre of European Commission. 2010. *ILCD handbook: Framework and requirements for LCIA models and indicators*. Luxembourg: Publications Office of the European Union.
- ISO. 2006a. *ISO 14040—environmental management—life cycle assessment—principles and framework (ISO 14040:2006)*. Geneva: ISO—International Organization for Standardization.
- ISO. 2006b. *ISO 14044—environmental management—life cycle assessment—requirements and guidelines*. Geneva: ISO—International Organization for Standardisation.
- Jenkins, N.T., and T.W. Eagar. 2005. Chemical analysis of welding fume particles. *Welding Journal* 84(6): 87s–93s.
- Klöpffer, W., and B. Grahl. 2009. *Ökobilanz (LCA): ein Leitfaden für Ausbildung und Beruf*. Weinheim: Wiley-VCH Verlag.
- Lezzi, F., and L. Costa. 2013. The development of conventional welding processes in naval construction. *Welding International* 27(10): 786–797. doi:10.1080/09507116.2012.753256.
- Neugebauer, S., J. Martinez-Blanco, R. Scheumann, and M. Finkbeiner. 2015. Enhancing the practical implementation of life cycle sustainability assessment—proposal of a Tiered approach. *Journal of Cleaner Production* 102: 165–176. doi:10.1016/j.jclepro.2015.04.053.
- PE Interational. 2014. Harmonization of LCA methodologies for metals—a whitepaper providing guidance for conducting LCAs for metals and metal products. <https://www.icmm.com/document/6657>. Accessed 9 July 2016.
- Pohlmann, G., C. Holzinger, and V.E. Spiegel-Ciobanu. 2013. Comparative investigations in order to characterise ultrafine particles in fumes in the case of welding and allied processes. *Welding and Cutting* 12(2): 97–105.
- Rose, S., M. Schnick, and U. Füssel. 2012. Cause-and-effect chains of fume formation in GMAW and possibilities of fume reduction by using new welding processes. IIW Document VIII-2147-12.
- Schau, E.M., Y.-J. Chang, R. Scheumann, and M. Finkbeiner. 2012. Manufactured products—how can their life cycle sustainability be measured?—A case study of a bamboo bicycle. Paper presented at The 10th Global Conference on Sustainable Manufacturing, October 31–November 2, Istanbul, Turkey.
- Spiegel-Ciobanu, V.E. 2012. Occupational health and safety regulations with regard to welding and assessment of the exposure to welding fumes and of their effect. *Welding and Cutting* 11 (1).
- Sproesser, G., Y. Chang, A. Pittner, M. Finkbeiner, and M. Rethmeier. 2015. Life cycle assessment of welding technologies for thick metal plate welds. *Journal of Cleaner Production* 108: 46–53. doi:10.1016/j.jclepro.2015.06.121.
- Sproesser, G., A. Pittner, and M. Rethmeier. 2016. Increasing performance and energy efficiency of gas metal arc welding by a high power tandem process. *Procedia CIRP* 40(2016): 642–647. doi:10.1016/j.procir.2016.01.148.
- Statistisches Bundesamt. 2016a. Minimum wages. <https://www.destatis.de/EN/FactsFigures/NationalEconomyEnvironment/EarningsLabourCosts/MinimumWages/MinimumWages.html>. Accessed 25 July 2016.

- Statistisches Bundesamt. 2016b. Poverty threshold and risk of poverty in Germany. [https://www.destatis.de/EN/FactsFigures/SocietyState/IncomeConsumptionLivingConditions/LivingConditionsRiskPoverty/Tables/EU\\_PovertyThresholdRisk\\_SILC.html](https://www.destatis.de/EN/FactsFigures/SocietyState/IncomeConsumptionLivingConditions/LivingConditionsRiskPoverty/Tables/EU_PovertyThresholdRisk_SILC.html). Accessed 25 July 2016.
- UNEP. 2009. The guidelines for social life cycle assessment of products. Nairobi, Kenya: United Nations Environment Programme. [http://www.unep.org/pdf/DTIE\\_PDFS/DTIx1164xPA-guidelines\\_sLCA.pdf](http://www.unep.org/pdf/DTIE_PDFS/DTIx1164xPA-guidelines_sLCA.pdf).
- World Steel Association. 2011. *Life cycle assessment methodology report*. Brussels: World Steel Association.

**Open Access** This chapter is licensed under the terms of the Creative Commons Attribution 4.0 International License (<http://creativecommons.org/licenses/by/4.0/>), which permits use, sharing, adaptation, distribution and reproduction in any medium or format, as long as you give appropriate credit to the original author(s) and the source, provide a link to the Creative Commons license and indicate if changes were made.

The images or other third party material in this chapter are included in the book's Creative Commons license, unless indicated otherwise in a credit line to the material. If material is not included in the book's Creative Commons license and your intended use is not permitted by statutory regulation or exceeds the permitted use, you will need to obtain permission directly from the copyright holder.



# Human-Centred Automation to Simplify the Path to Social and Economic Sustainability

The Duy Nguyen and Jörg Krüger

**Abstract** Musculoskeletal Disorders (MSDs) pose a serious threat to sustainability in manufacturing. In particular, this phenomenon impacts the sustainability indicators of worker health and safety and the Gross Domestic Product (GDP). Effective MSD prevention measures would therefore constitute a remarkable contribution to social and economic sustainability. This chapter provides first an outline of existing methods to prevent MSD at the workplace. Analysis of the approaches yields that effective solutions require earmarked finances as well as qualified personnel, both of which are not affordable for many companies. In pursuit of solutions, Human-centred Automation (HCA), a recent paradigm in manufacturing, proposes the design of manufacturing systems using intelligent technology to support the worker instead of replacing him/her. HCA has the unique potential of reducing the effort needed to implement MSD prevention strategies by simplifying the path to social and economic sustainability. This chapter demonstrates this process with the example of the “Working Posture Controller” (WPC), which illustrates how the HCA concept can be applied. Finally, the lessons learned from the case are outlined, providing a vision of how future workplaces can benefit from HCA.

**Keywords** Musculoskeletal disorders · Human-centred automation · Human-machine interaction

## 1 Work-Related Musculoskeletal Disorders—A Sustainability Challenge

The health of the workforce is vital for social as well as economic sustainability. The Guideline for Social Life Cycle Assessment of Products (Benoît et al. 2010) describes “worker health and safety” as a major impact category among social

---

T.D. Nguyen (✉) · J. Krüger  
Technische Universität Berlin, Berlin, Germany  
e-mail: theduy.nguyen@iat.tu-berlin.de



sustainability indicators. In terms of economic sustainability, direct costs due to unfavourable working conditions reduce a country's Gross Domestic Product (GDP) (Bevan 2015), which is considered to be one of the main economic sustainability indicators defined by the United Nations—Department of Economic and Social Affairs (2007).

Musculoskeletal Disorders (MSDs) present a serious threat to the health of the workforce, and thus, to sustainability. The European Agency for Safety and Health at Work (Schneider et al. 2010) defines MSDs as “health problems of the locomotor apparatus, which includes muscles, tendons, the skeleton, cartilage, the vascular system, ligaments and nerves.” Work-related or Occupational Musculoskeletal Disorders (WMSDs) encompass all MSDs that are caused or worsened by work.

WMSDs as a sustainability indicator are not explicitly mentioned in the “health and safety” impact group in Benoît et al. (2010). However, this represents more of an oversimplification of the guideline than a negligible effect. In fact, the only measures which are considered are those which result from suboptimal working conditions, such as the number of injuries or accidents (Chang et al. 2016). Accumulative effects, such as WMSDs go completely neglected although they pose a comparable impact. The European Labour Force Survey (Camarota 2007) concluded that MSDs accounted for 53 % of all work-related diseases in the EU-15, therein representing the most frequent cause (Bevan 2015). The number of lost days due to WMSDs is estimated at 350 million (Delleman et al. 2004) in the EU. In terms of economic sustainability, WMSDs significantly reduce the GDP of the EU. The total costs of WMSDs is estimated at 240€ billion, which translates into up to 2 % of the EU GDP (Bevan 2015).

Due to its impact, researchers from different scientific disciplines, such as human factors science, medicine and engineering, have developed methods to prevent WMSDs, reducing their risk of occurrence. Significant successes have been achieved. On average, methods implemented have turned out to cover their total costs in less than 1 year (Goggins et al. 2008). Nevertheless, implementing effective measures requires tedious work on the part of highly qualified ergonomists, which makes effective WMSD prevention not realisable for every company.

Human Centred Automation (HCA) denotes a recent development in manufacturing technology. This engineering paradigm proposes turning away from fully automated production lines in favour of systems where man and machine collaborate and combine the strengths of both participants. Instead of replacing the worker, the machine's task is to support him/her. The system can enhance cognitive skills through intelligent sensors or provide additional physical capabilities through actuators. By automatising the parts of the WMSD prevention methods which require highly skilled personnel or tedious work, HCA helps to make these techniques available to a broader mass. To sum up, the contribution of HCA to sustainability lies in providing access to sustainability enhancing techniques.

This chapter concentrates on one main risk factor causing WMSDs: unfavourable working posture, which is often referred to in literature as “awkward posture” (Delleman et al. 2004). An exemplary technique is presented on how HCA can be applied to solve existing WMSD prevention problems, and thus, support

sustainability goals in manufacturing. Section 2 provides an overview of common state-of-the-art approaches in tackling WMSDs, outlining a fundamental problem: the effectiveness–flexibility trade-off. The HCA, which appears to be a promising solution to the effectiveness–flexibility trade-off, is presented in Sect. 3. Afterwards, Sect. 4 presents the Working Posture Controller (WPC). The WPC is a device which demonstrates how the HCA paradigm is used to overcome the effectiveness–flexibility trade-off. Finally, this chapter concludes with the facts learned.

## 2 State-of-the-Art of WMSD Prevention

Due to its high impact on human health and the economy, the area of WMSD prevention is an extensive research field. Researchers from various disciplines such as, human factors, medicine or engineering, have proposed their solutions. In scientific literature, the measures are often referred to as “ergonomic interventions.” This section outlines the most important developments.

In brief, the techniques presented can be grouped into three categories: technical measures, organisational measures or individual measures (Van der Molen et al. 2005). Alternatively, Bergamasco et al. (1998) use the term “training” instead of individual measure.

Technical measures involve modifications of the working environment and the process. Examples include designing the workplace layout, process design, or the introduction of special equipment to support the worker. Workplace layout design aims at rearranging the workplace geometry in such a way that tasks can be efficiently accomplished without the need for adopting awkward postures. To that effect, ergonomic guidelines have been released to provide the workplace designer with a tool for checking the appropriateness of the developed workplace (Das and Grady 1983). The set of ergonomic guidelines is complex and highly dependent on the tasks at hand and on the individual person. Often, multiple physical prototypes have to be evaluated (Delleman et al. 2004). Digital Human Models (DHM) have become a popular method for assisting in the design process (Lämkuhl et al. 2009) by means of simulating the prototypes. Technical measures also imply the introduction of equipment, such as lifting aids or human robot collaboration systems to execute physically demanding tasks on behalf of the worker (Krüger et al. 2009; Busch et al. 2012; Weidner et al. 2013; Schmidtler et al. 2014). Another type of equipment is found in alert systems which monitor the process and warn the user as soon as an ergonomically unfavourable situation arises (Vignais et al. 2013).

In addition, organisational measures (Paul et al. 1999) entail techniques which aim at avoiding an unacceptable amount of load through customised and calculated, balanced scheduling of the tasks. The idea is to compose the set of tasks for a worker in a way such that multiple regions of the body are alternatingly strained. This avoids the monotonous strain of one particular body structure leading to long-term damage. This technique is called job rotation.